

Cromer Bed

- | | | |
|---|---|--|
| D Montageanleitung
Bett Cromer | GB Assembly instructions
Bed Cromer | FR Notice de montage
Lit Cromer |
| NL Montage-instructies
Bed Cromer | PL Instrukcje montażu
Łózko Cromer | SK Návod na montáž
Postel Cromer |
| TR Montaj talimatları
Yatak Cromer | RU Инструкция по монтажу
Bed Cromer | HU Szerelési útmutató
Agy Cromer |
| IT Istruzioni di montaggio
Letto Cromer | CZ Montážní návod
Postel Cromer | RO Instrucțiuni de montaj
Pat Cromer |

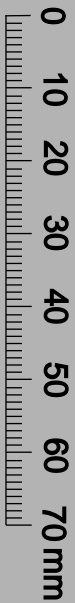

Service • Dienstverlening • Serwis • Servis • Сервисная служба

Name. Naam. Nom. Name
Cromer
Article no., artikelnr., No. d'article, Artikelnummer
Type. Typ
Colour. Kleur. Couleur. Farbe
White - Weis

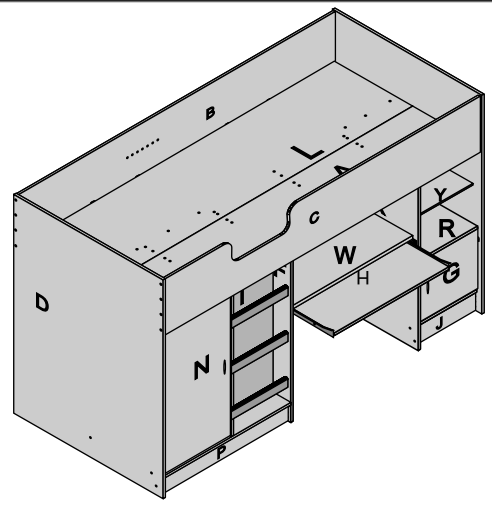

A — 1	D — 1	G — 1	K — 1	N — 1	R — 2	W — 1
B — 1	E — 1	H — 1	L — 1	P — 1	S — 1	Y — 1
C — 1	F — 1	J — 1	M — 1	Q — 1	T — 1	

94 x 38cm x 3mm 94 x 81cm x 3mm

6 x "23" 18mm Barrel Nut	2 x "122" 32mm door stop	20 x "44" 12mm x No6 BZP Pozí, CSK	1 x "25" 4mm Allen key	46 x "28" 50mm Confixmat	25 x "13" Pins	56 x "43" 12xno8 Pan BZP Pozí	Oval Rail
4 x "205" 17mm Crank Hinge	4 x "206" 26mm Hinge Plate	6 x "18" 51 x 6mm Bolts	16 x "106" U Capt Shelf Support	2 x "118" Hang supp	1 x "151" DT 484	26 x "155" DT 484	1 "125" 79cm
8 x "14" 6mm Locknut	10 x "30" 45mm screws	6 x "238" 10mm dowel	60 x "220" 38 x 6mm dowel	46 x "104" Confixmat Cover Caps	2 x "131" 64mm Metal D Handle	"17" Nail Tool	4 X "100" 5mm Shelf Support
4 x "19" M4 x 23mm Pan	8 x "54" 26mm x M6	2 x "165" FP 62 Plate		1 x "219" Glue	1 x "62" MDF Foot Rail 36cm		
4 x "42" 15x4mm Pan BZP Pozí	8 x "36" 25mm x No6 BZP Pozí, CSK	4 x '58' KD Block	2 x "146" 27mm bracket	1 x "534" 220cm	3 x "570" MDF Foot Rail 36cm		

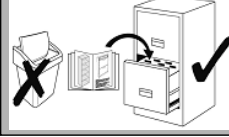
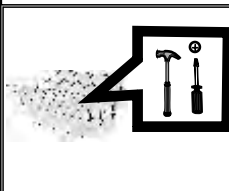
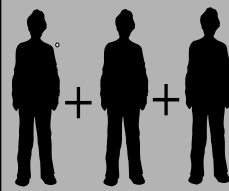

Cromer High Bed

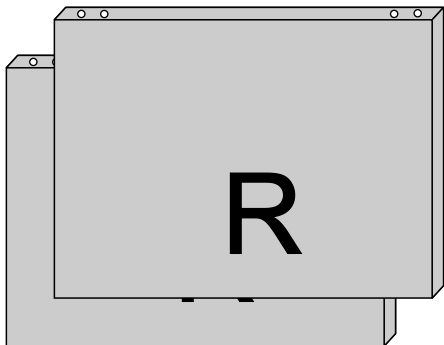
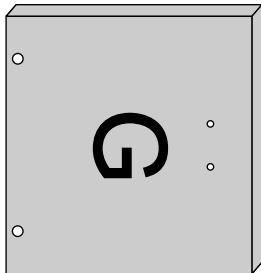
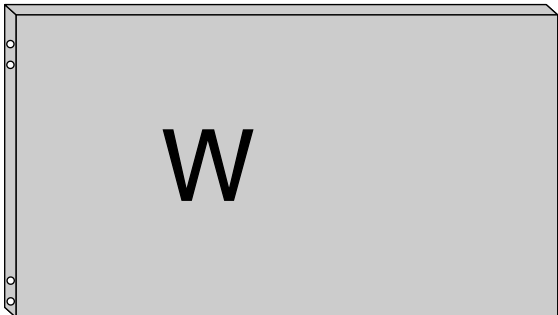
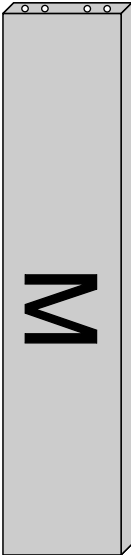
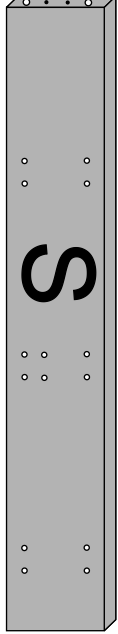
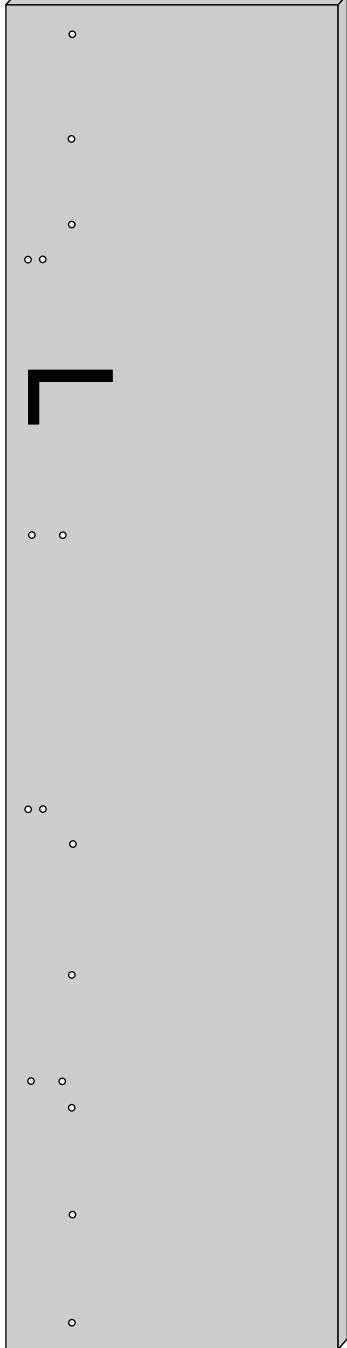
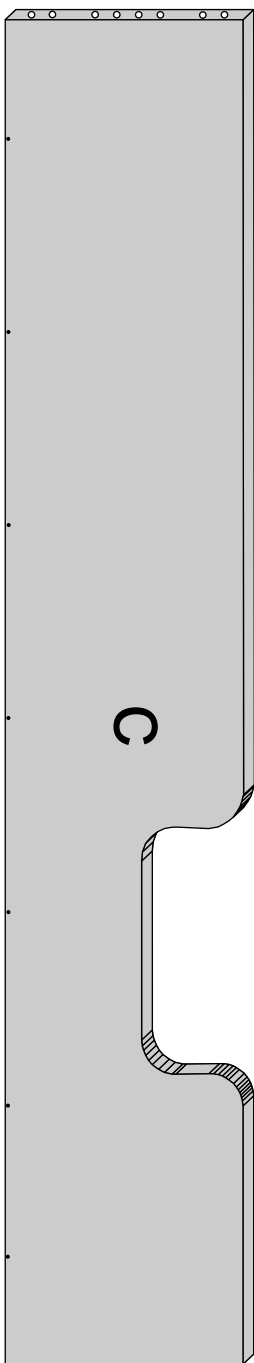
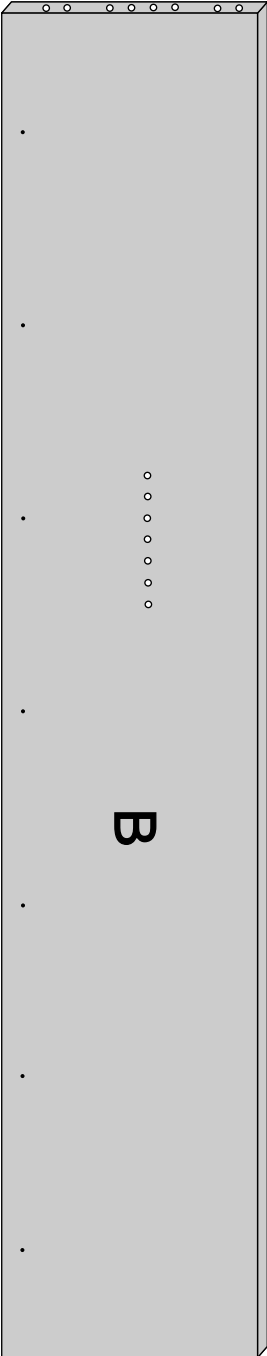
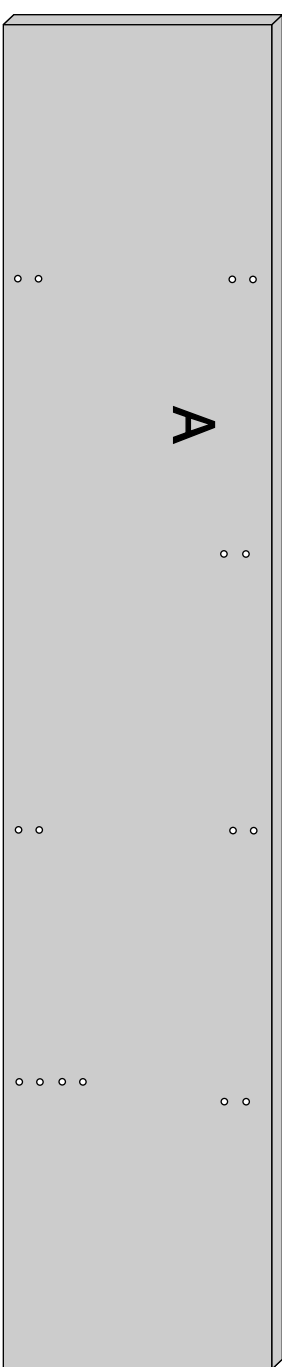

94 x 38cm x 3mm
94 x 81cm x 3mm

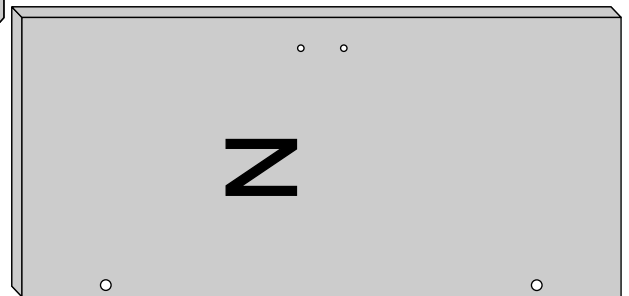
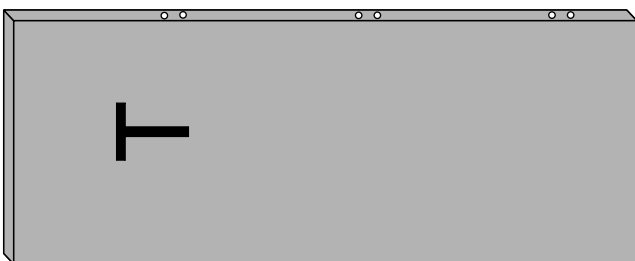
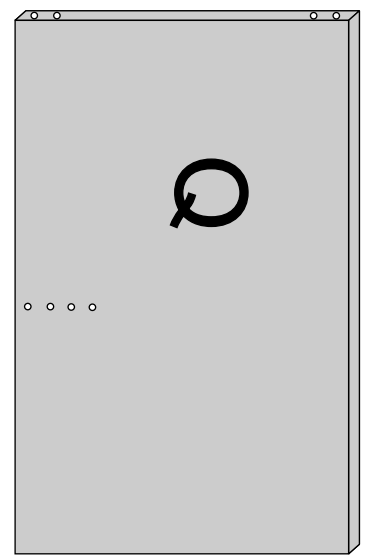
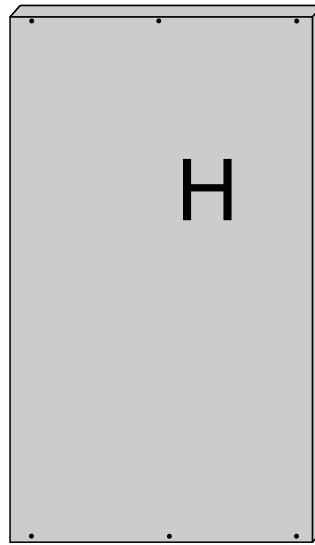
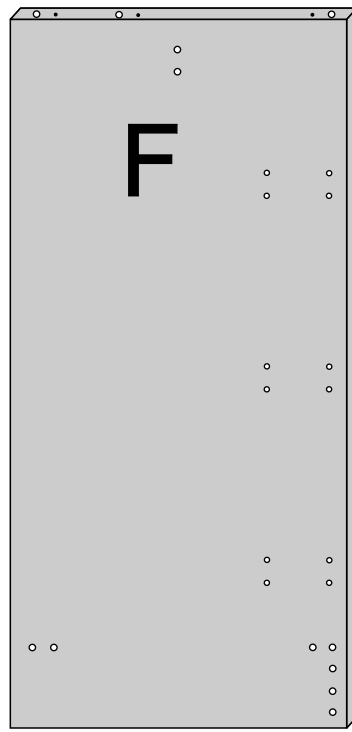
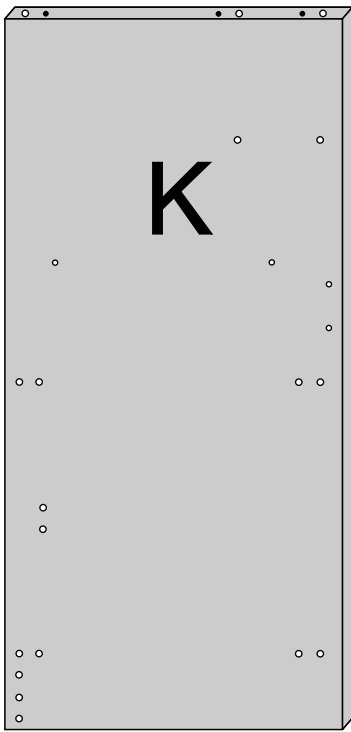
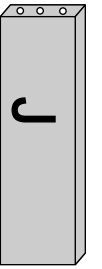
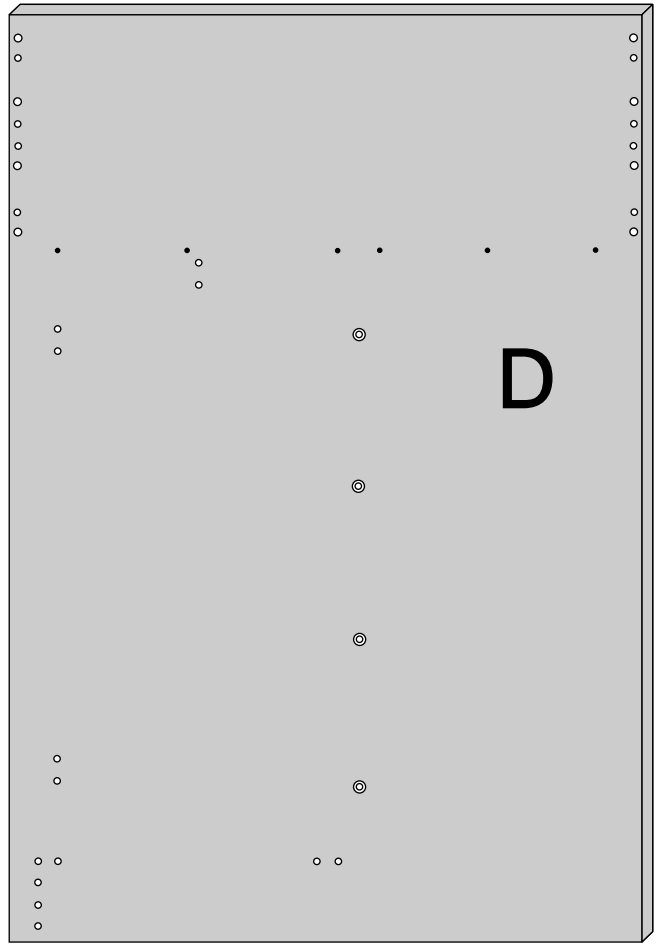
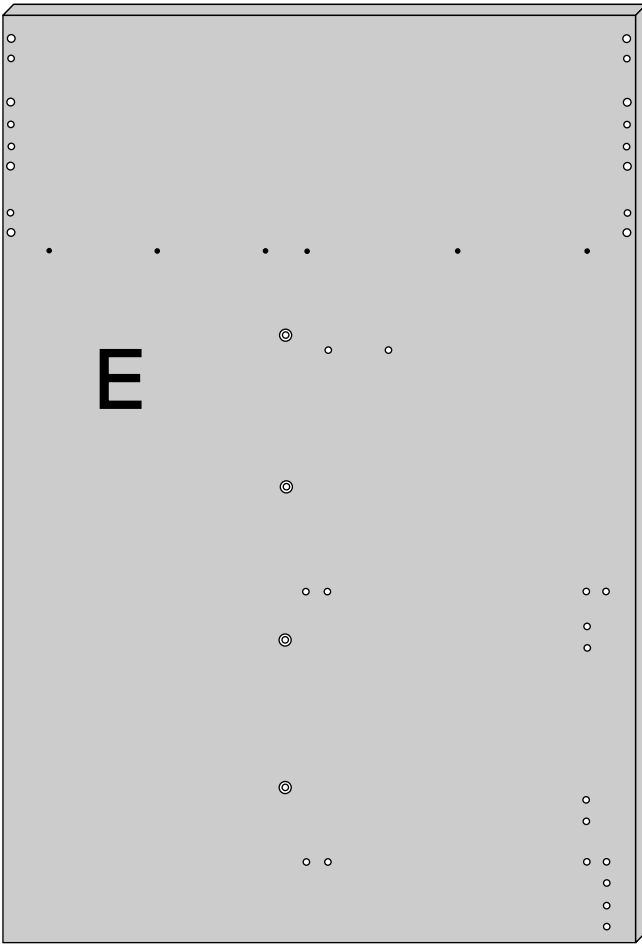

Cromer

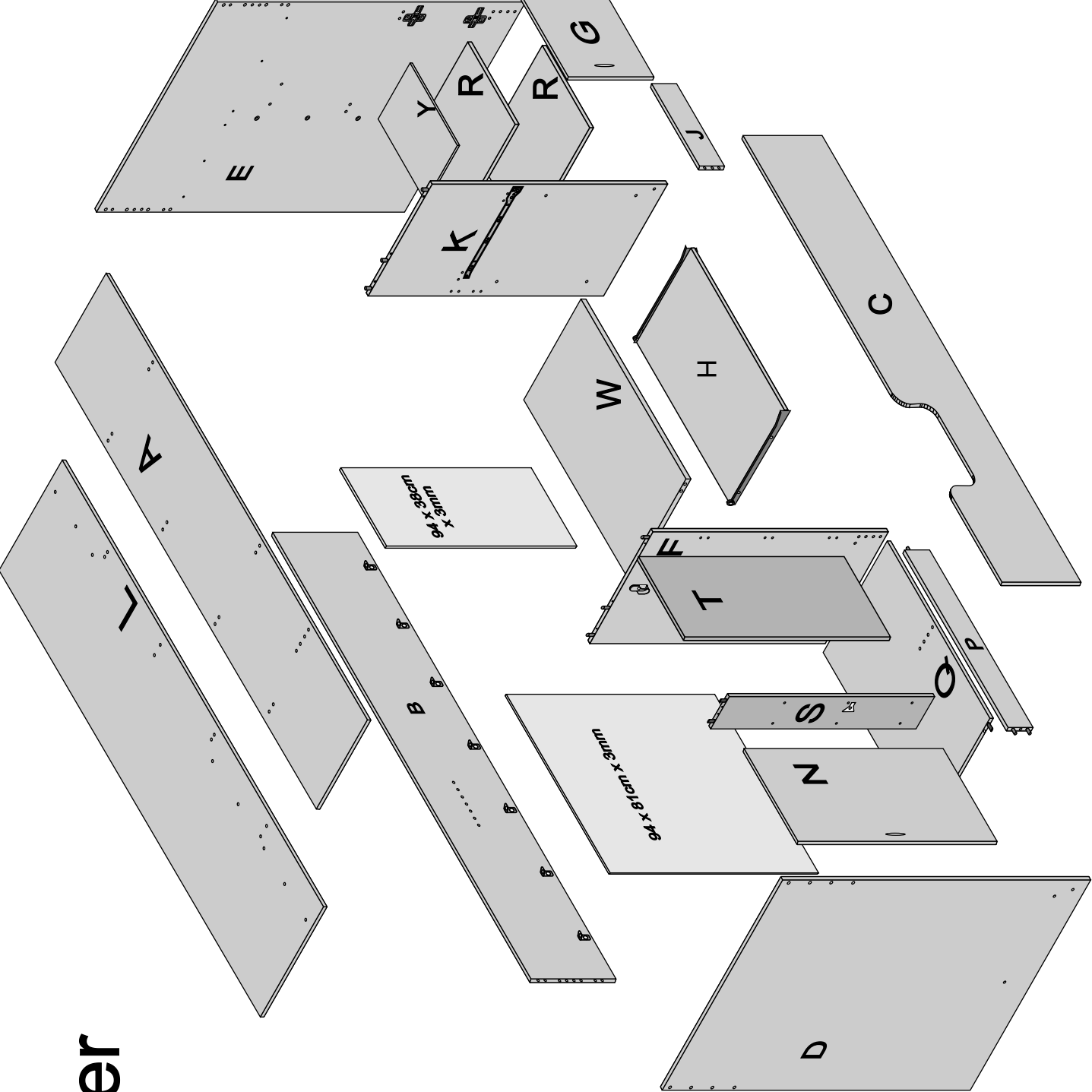

1

STEP 1 of 18 Cromer High Bed

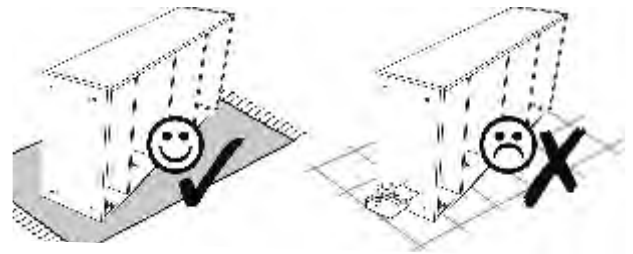
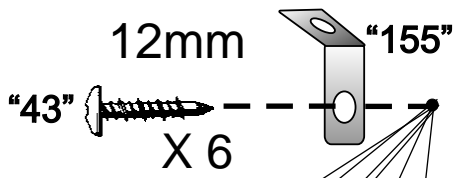

12 x "43"	12 x "155"	1 x "44"	1 x "118"	4 x "206"

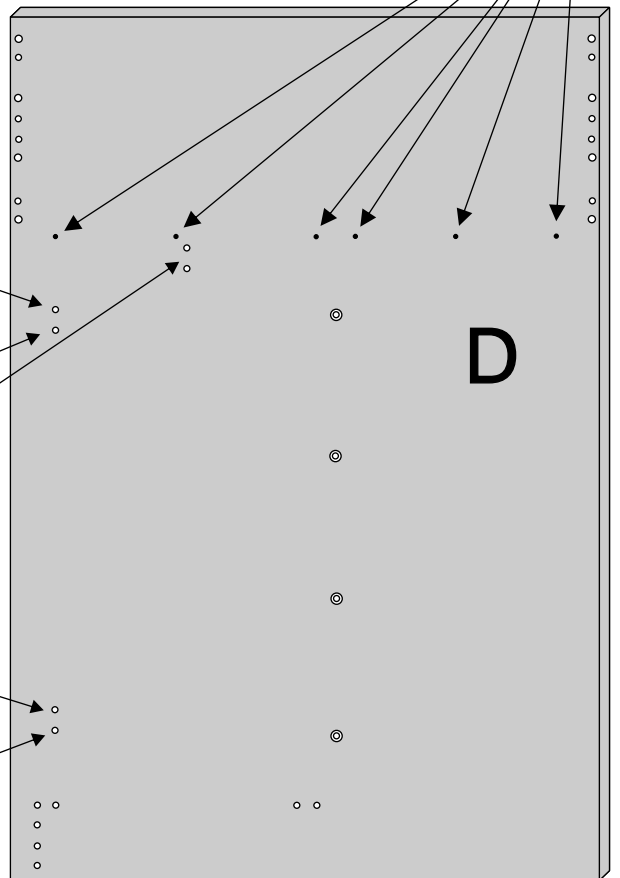
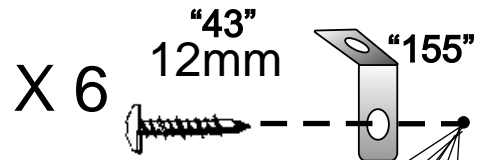
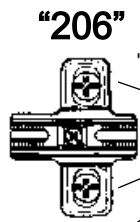
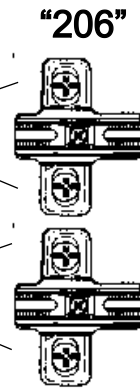
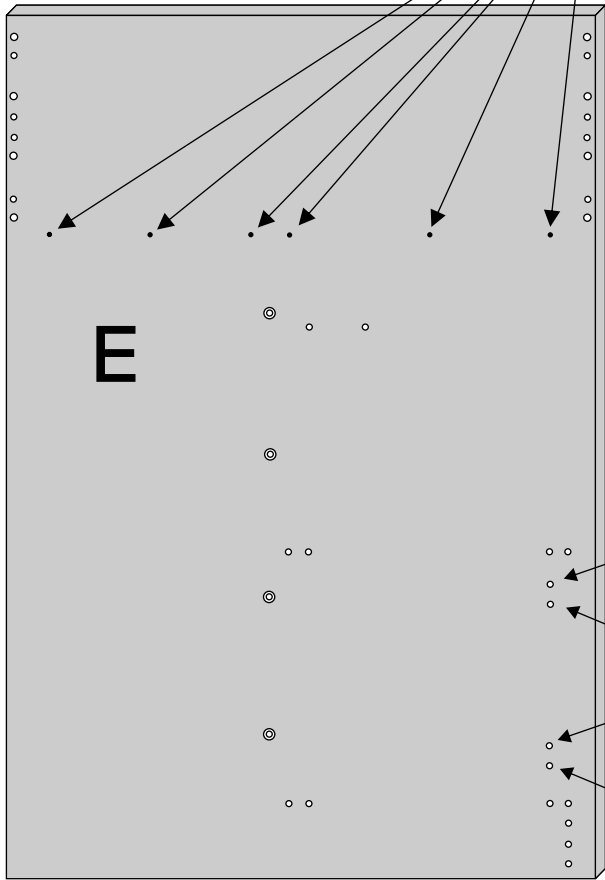

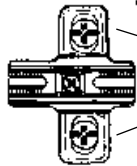
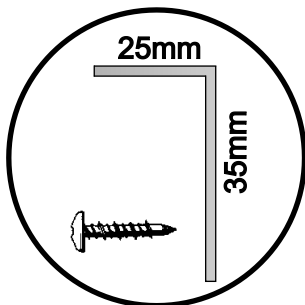
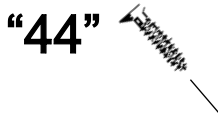

1 x 12mm

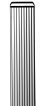

2

STEP 2 of 18 Cromer High Bed

		
16 x "220"	14 x "43"	14 x "155"

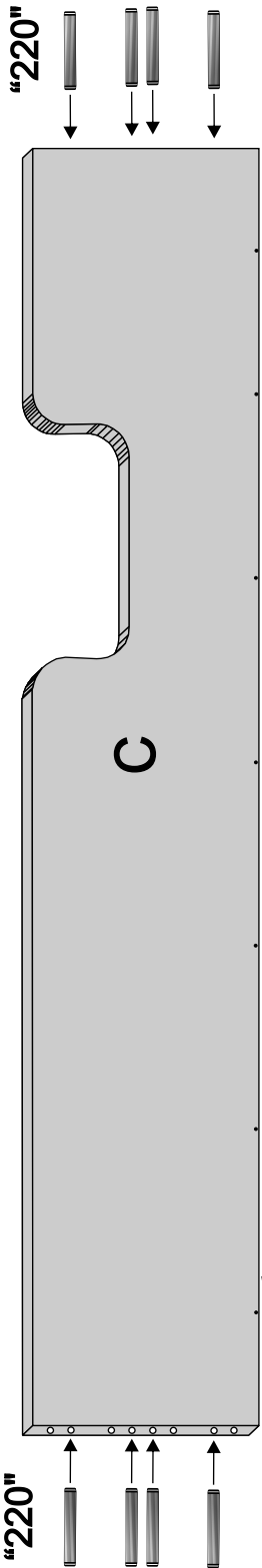
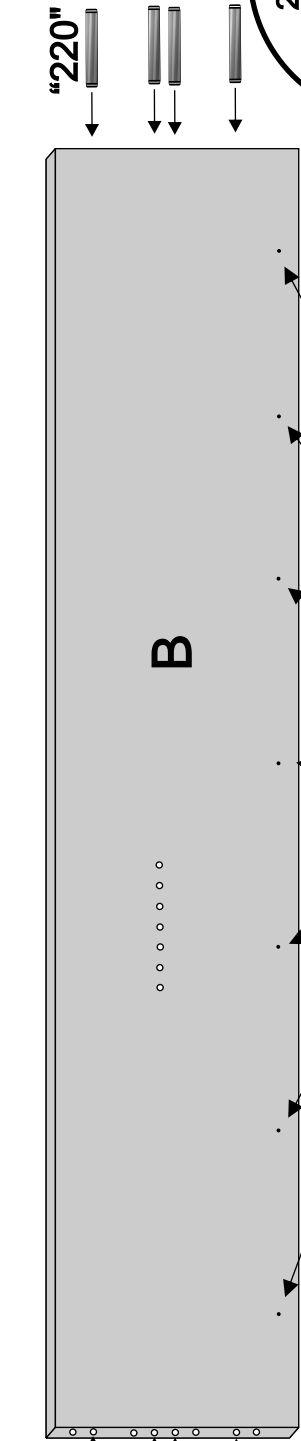

B

X 7

"155"

12mm

C

X 7

"155"

12mm

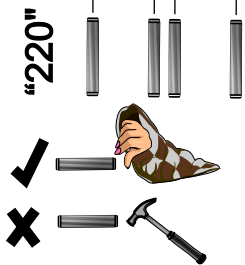



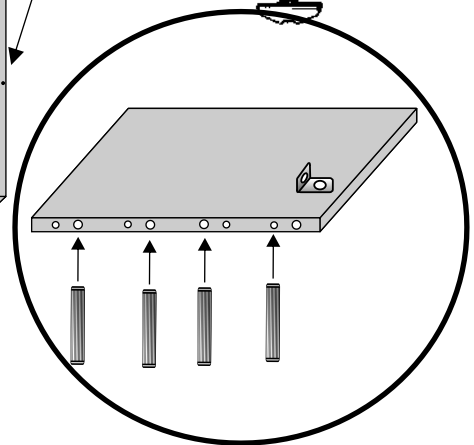
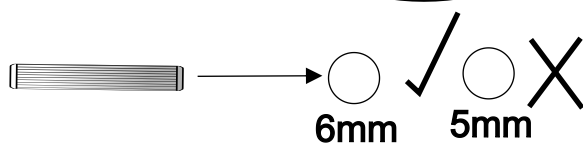
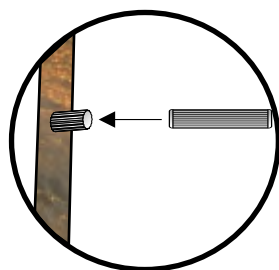

Max 11mm



STEP 3 of 18 Cromer High Bed

3

			
22 x "220"	2 x "44"	1 x "118"	1 x "122"

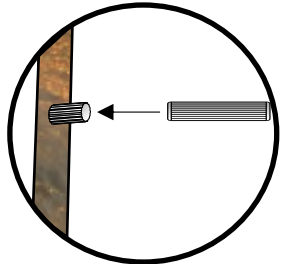
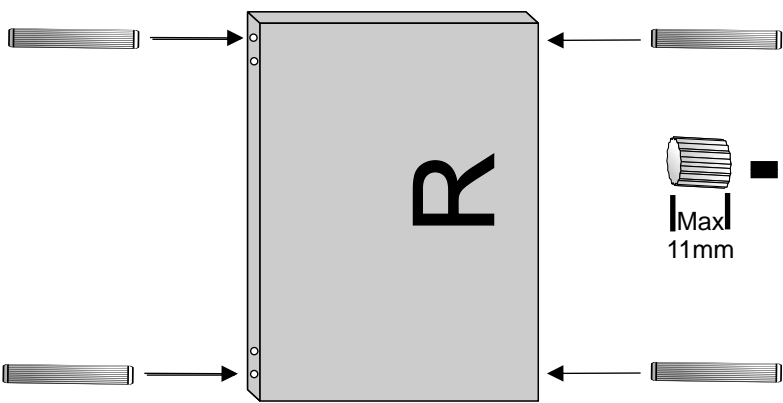
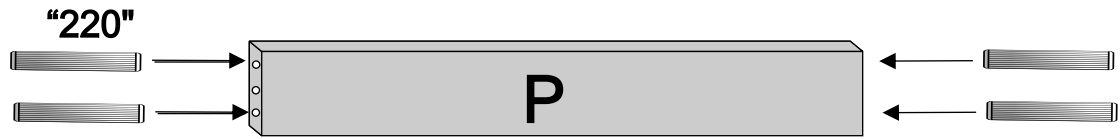
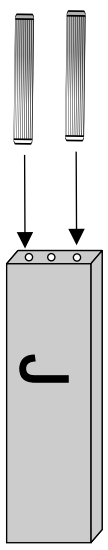
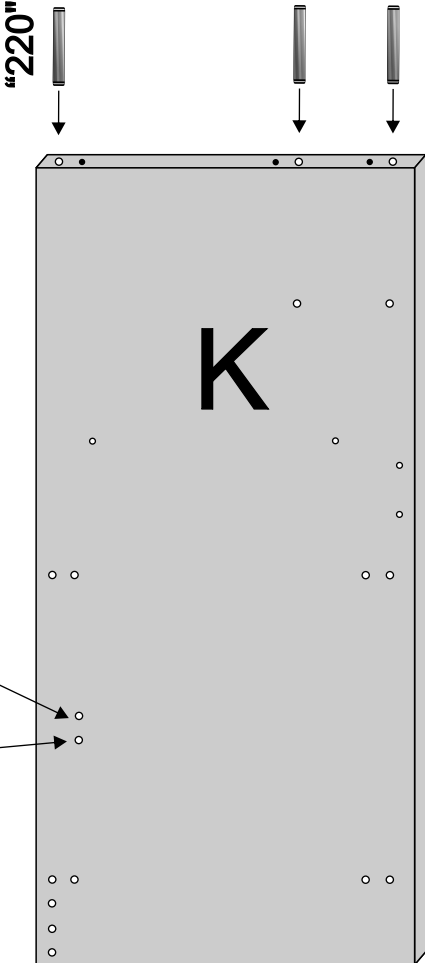
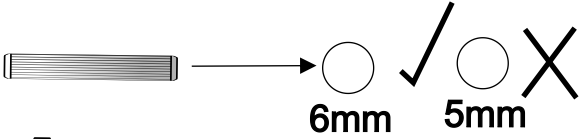
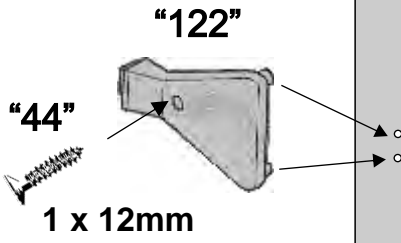
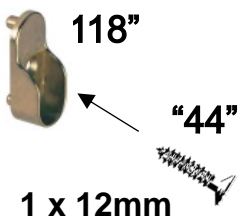
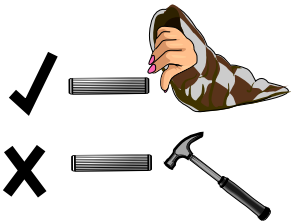
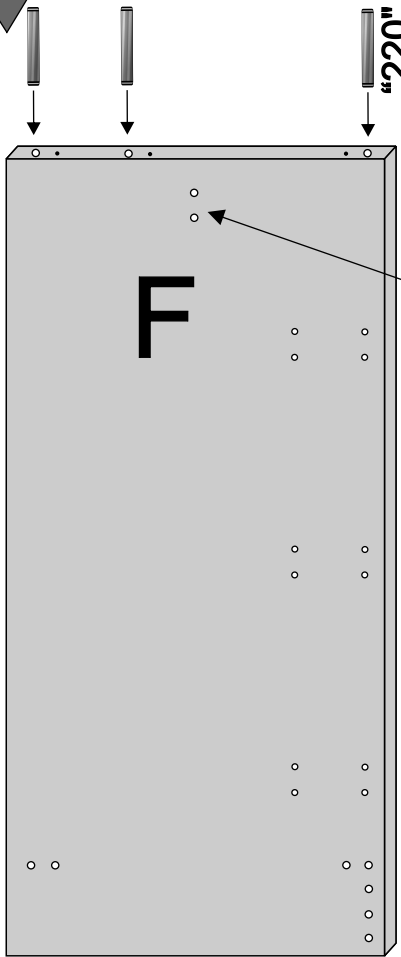



"220"

"220"

x 2

4

STEP 4 of 18 Cromer High Bed

 12mm		
1 x "44"	16 x "220"	1 x "122"

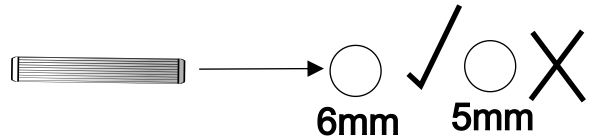
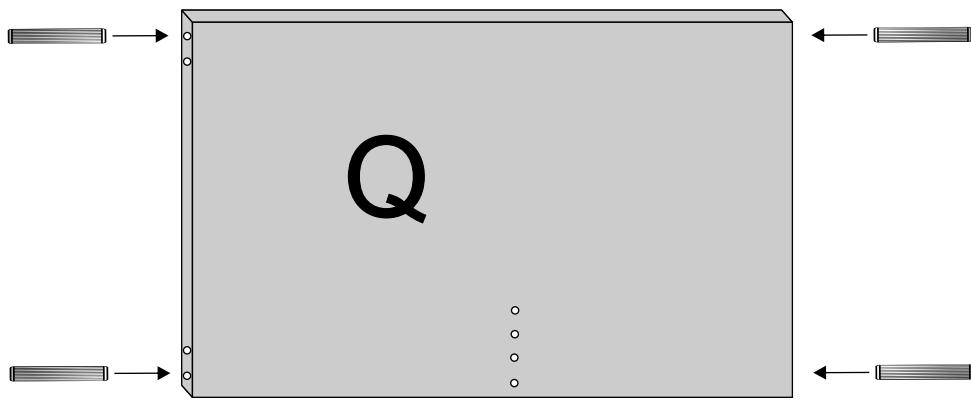
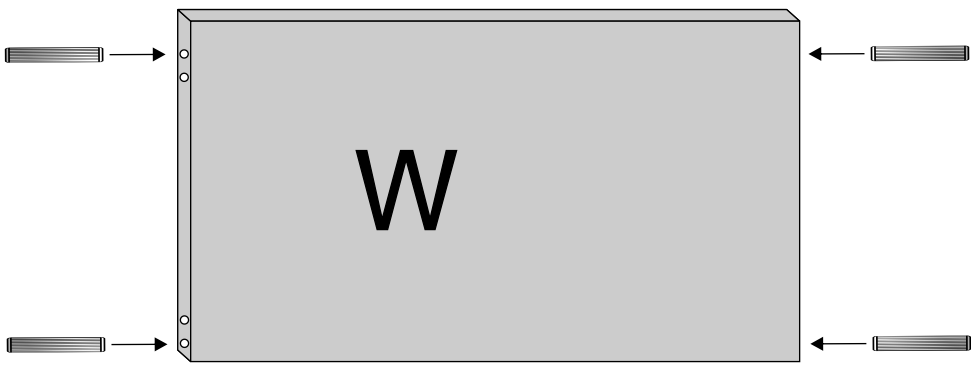
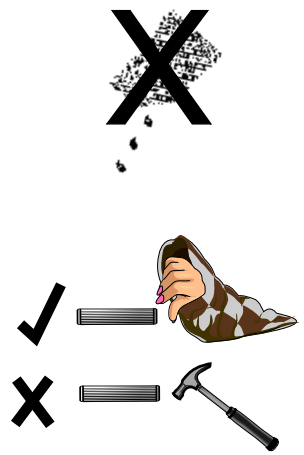
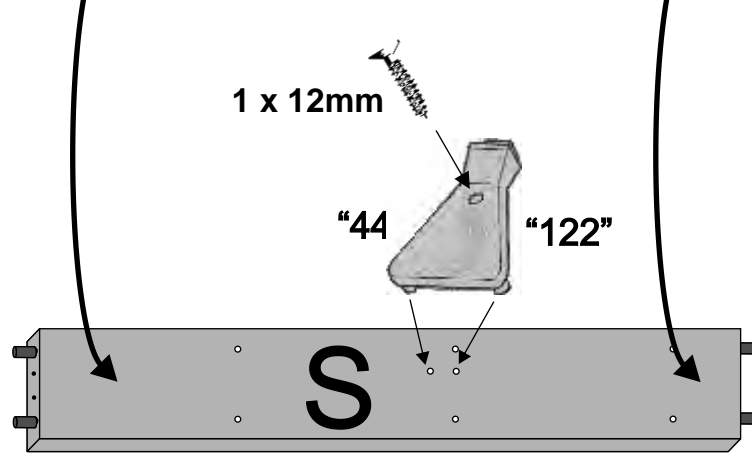
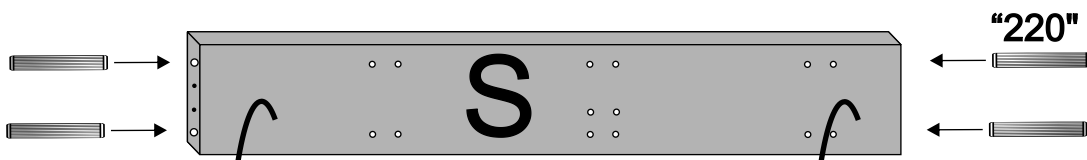
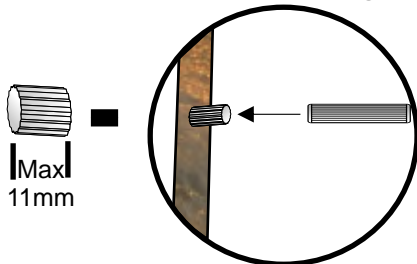

STEP 5 of 18 Cromer High Bed

5

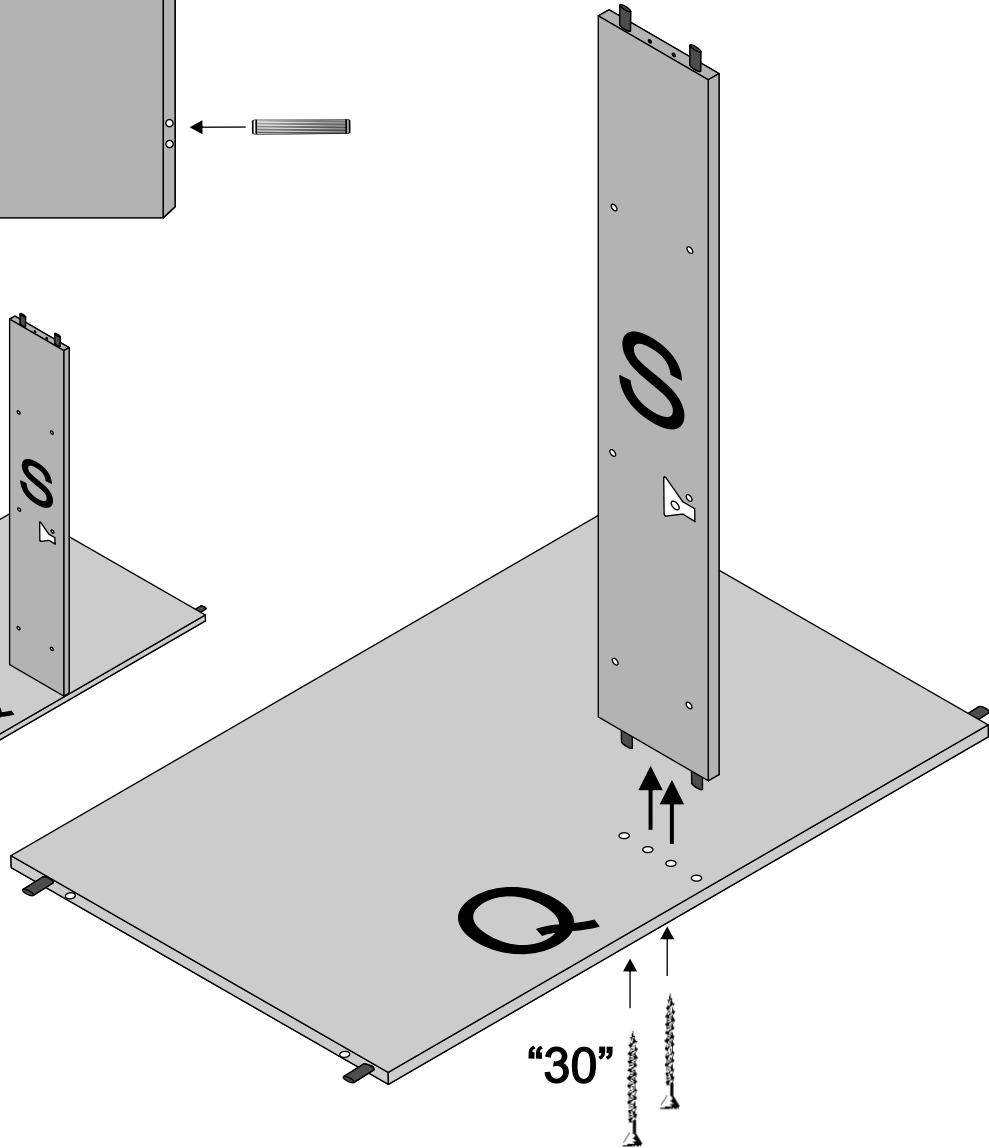
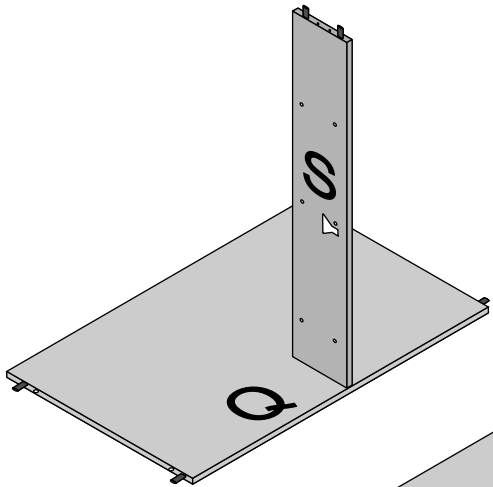
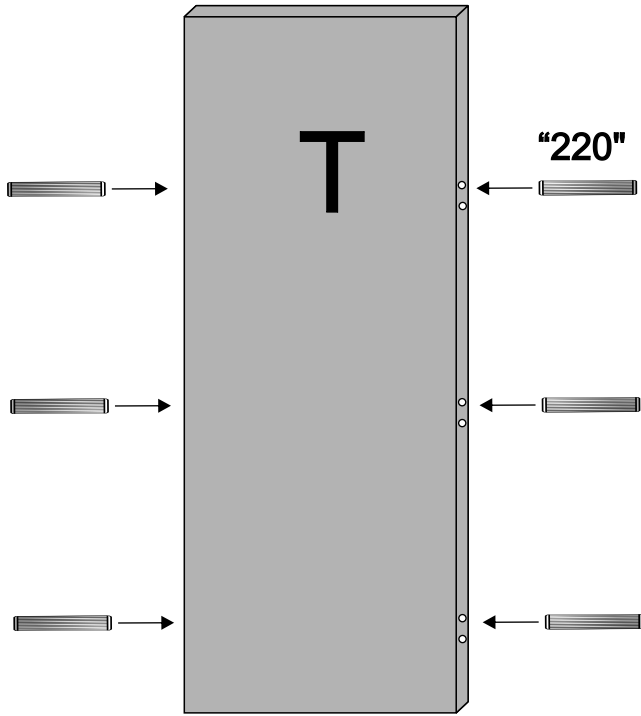
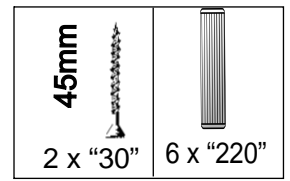
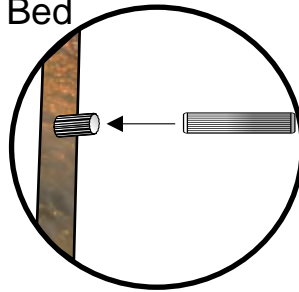
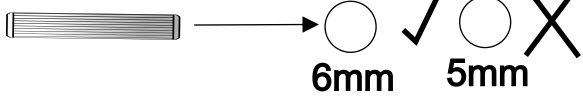

6

STEP 6 of 18 Cromer High Bed



7

= A/B

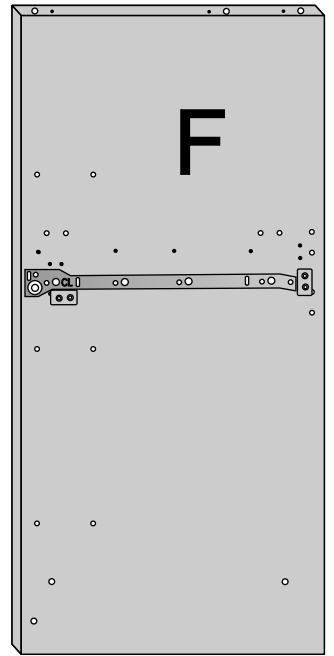
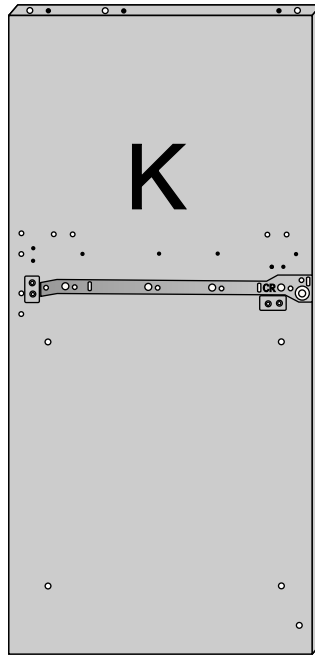
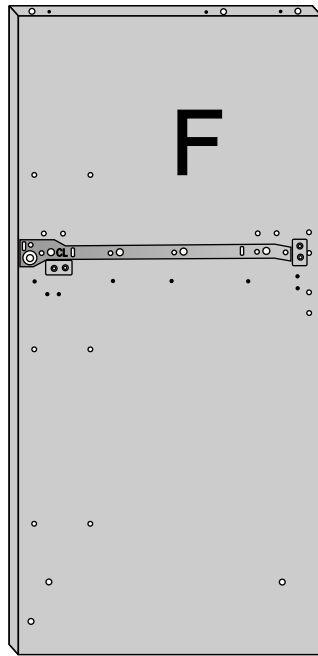
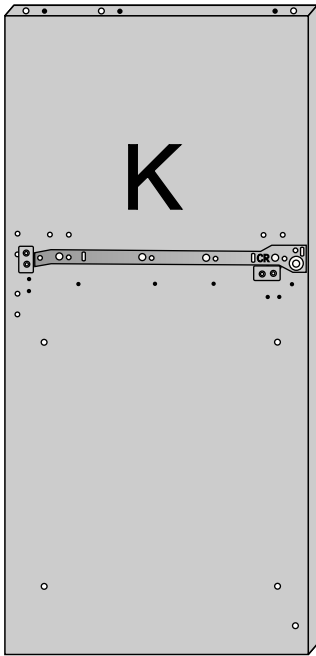

A

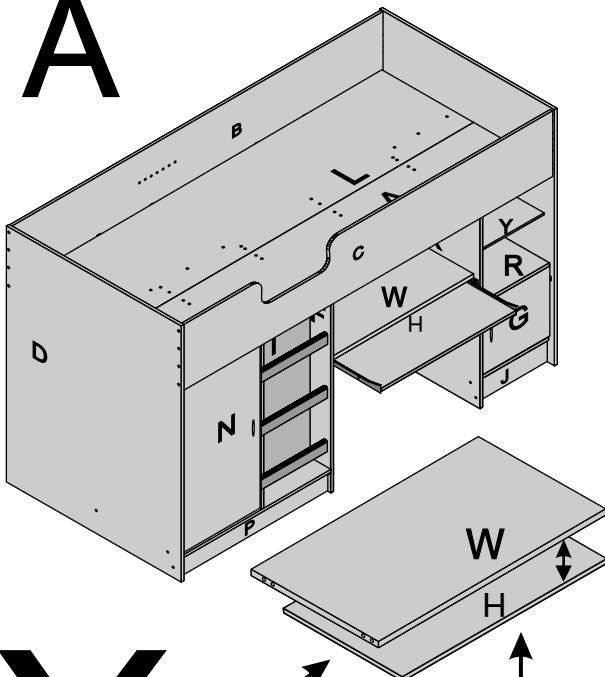

2 cm

B

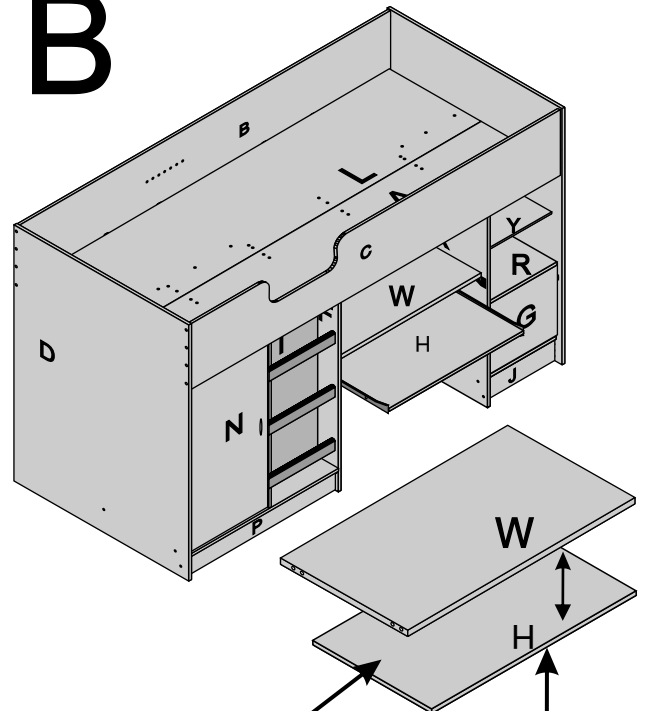





7 cm

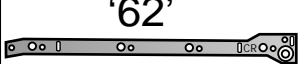
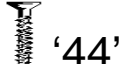

7

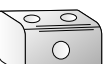
STEP 7 of 18 Cromer High Bed

 '62' CR	 '44' 12mm	 '36' 25mm	 '58' 4
 CL	8	8	4

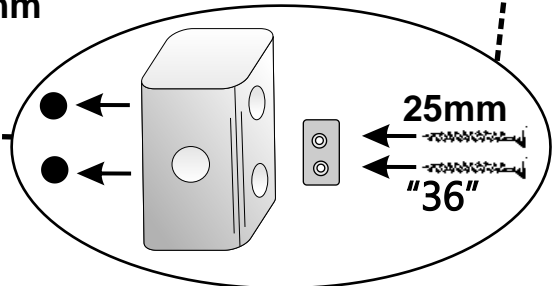
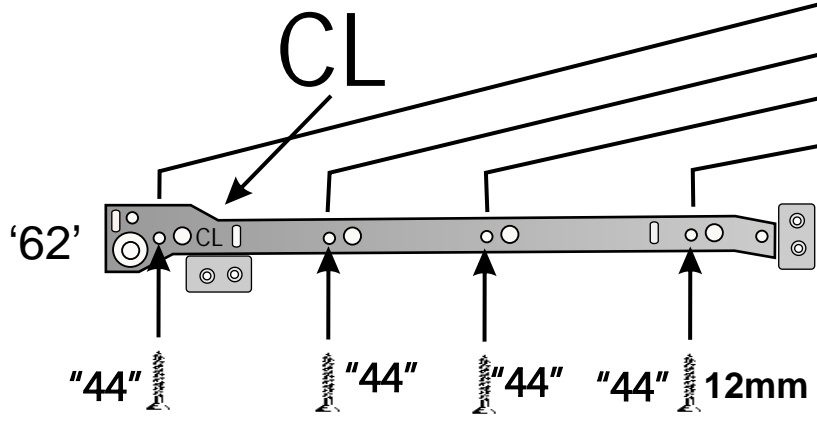
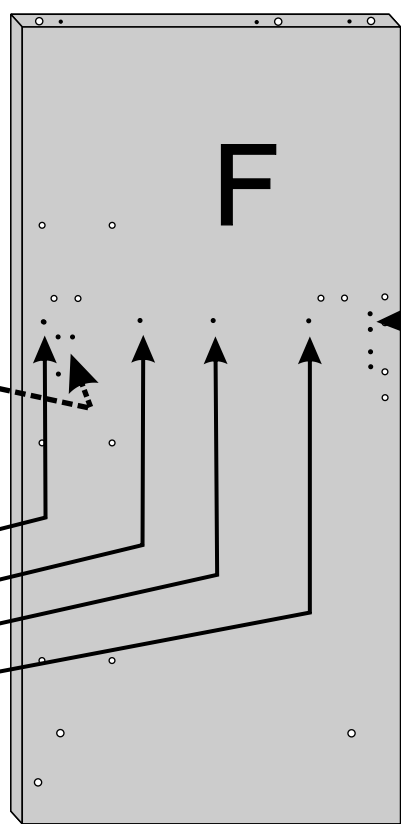
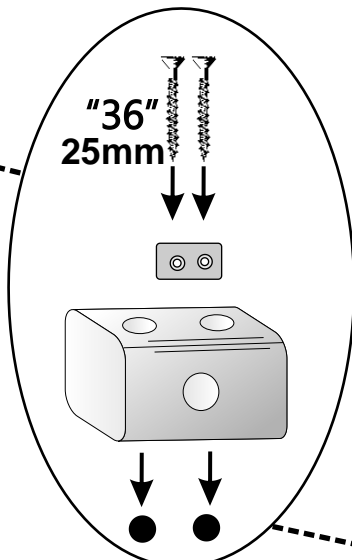
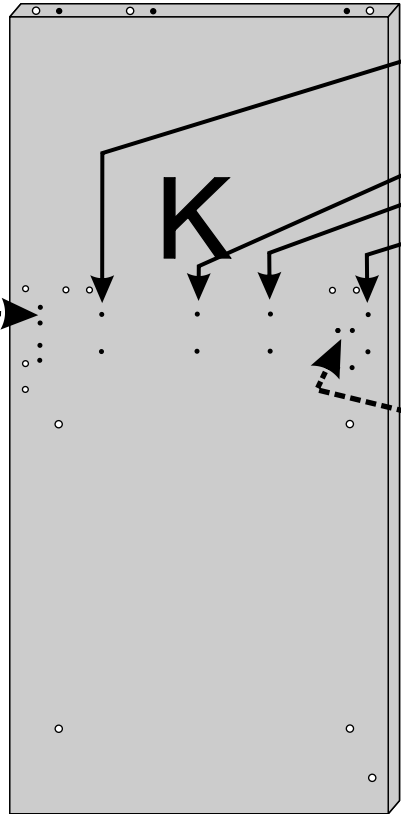
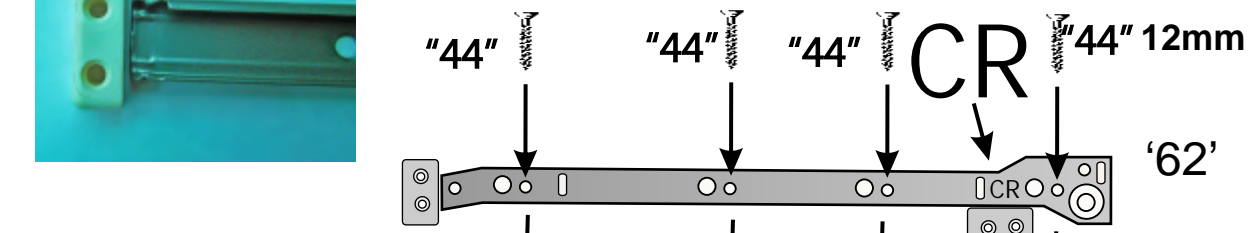





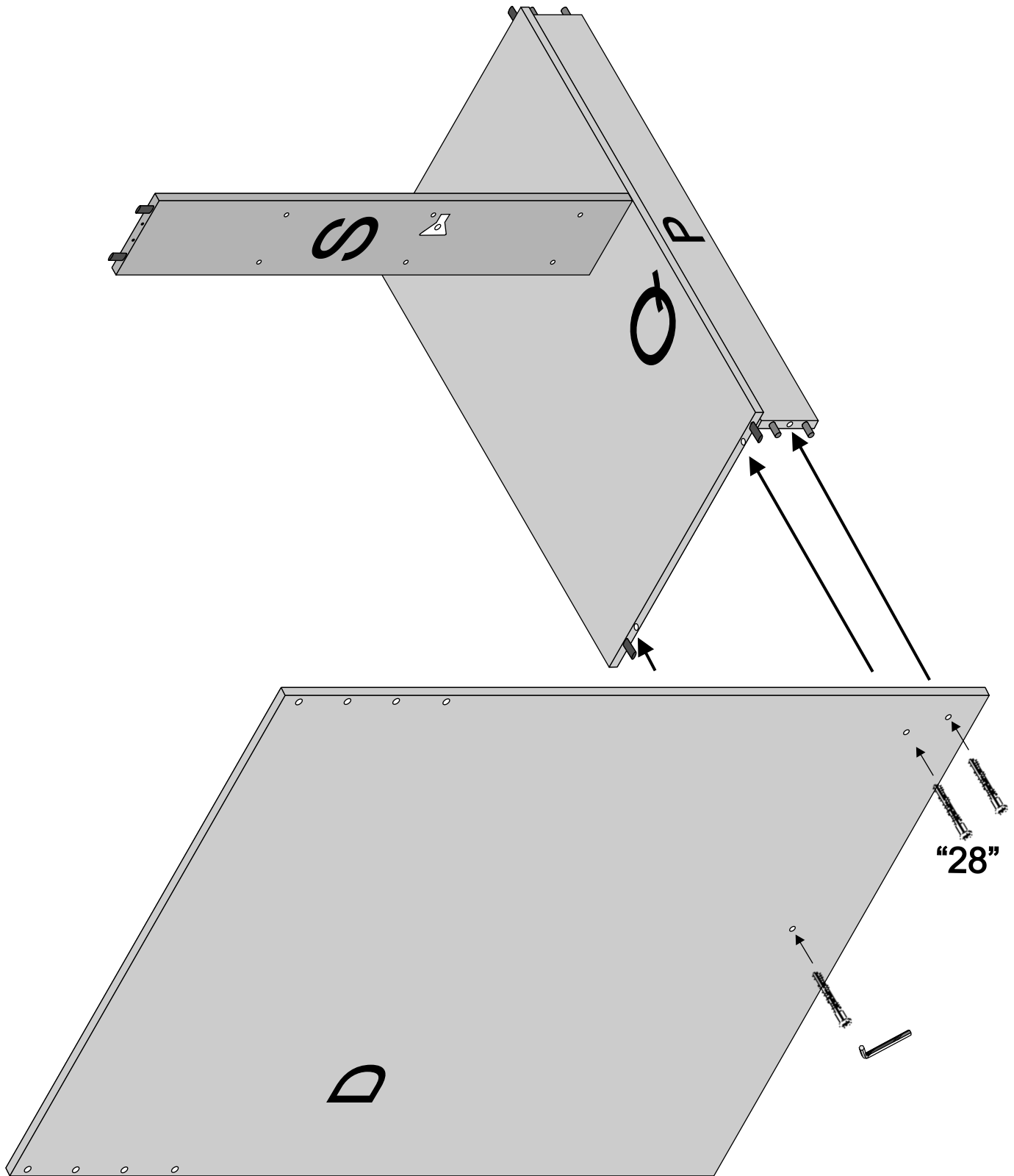
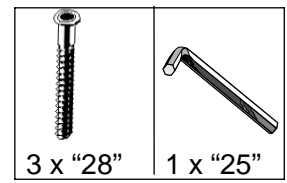

8

STEP 8 of 18 Cromer High Bed



9

STEP 9 of 18 Cromer High Bed

					
9 x "28"	6 x "23"	6 x "238"	"219"	6 x "18"	1 x "151"

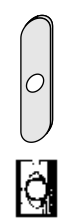
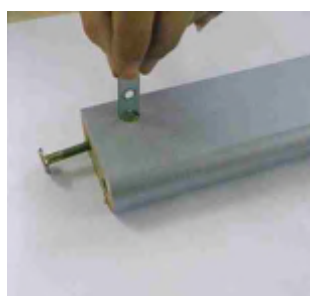
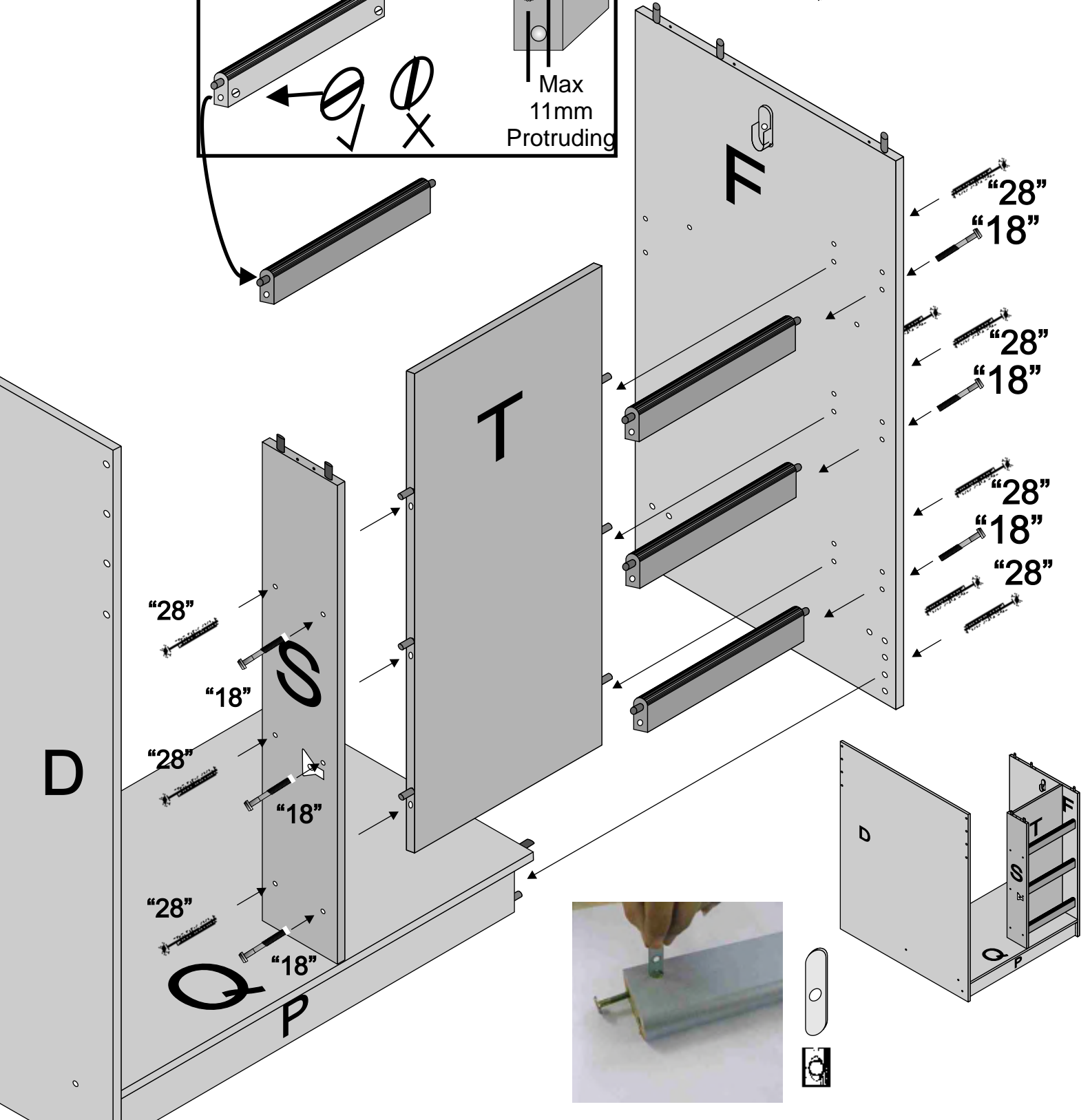
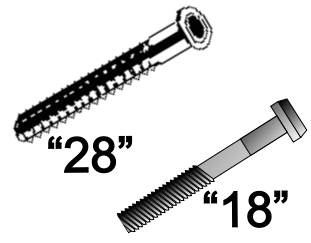
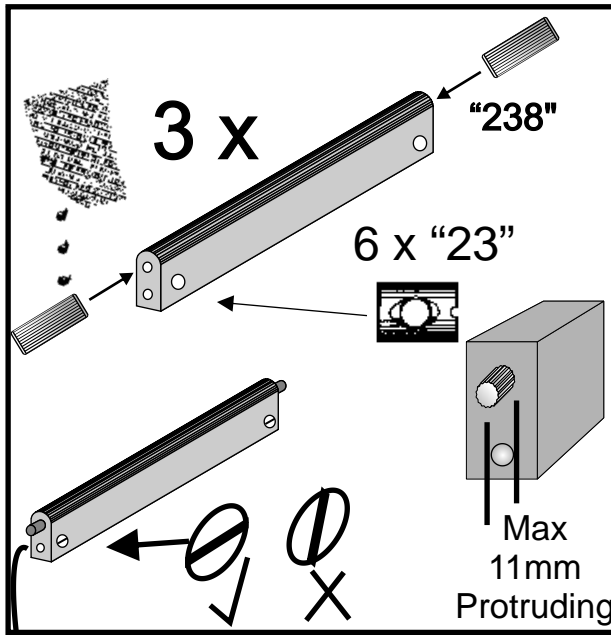

10

STEP 10 of 18 Cromer High Bed

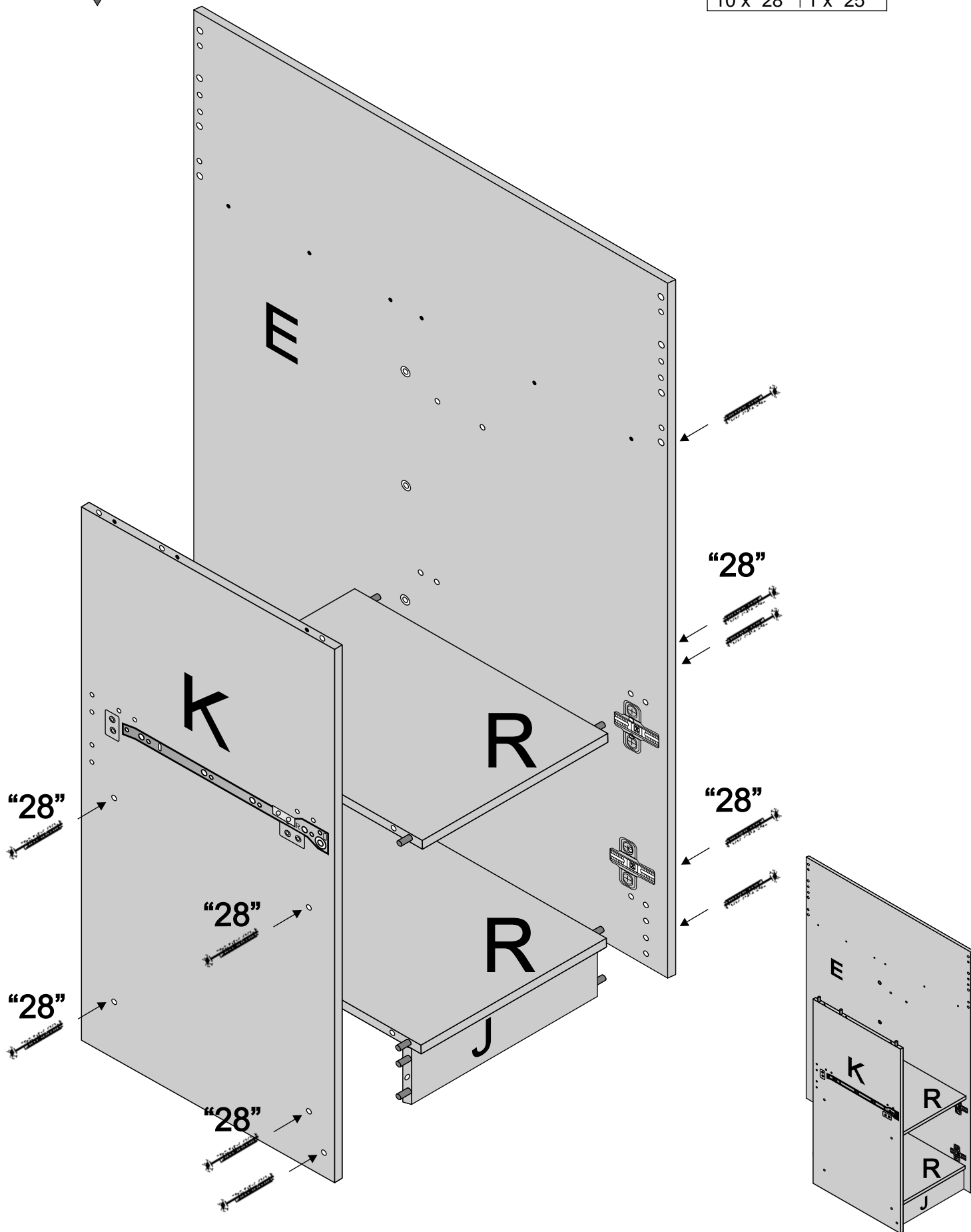
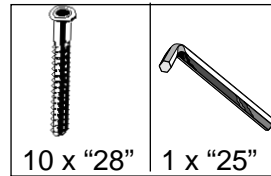

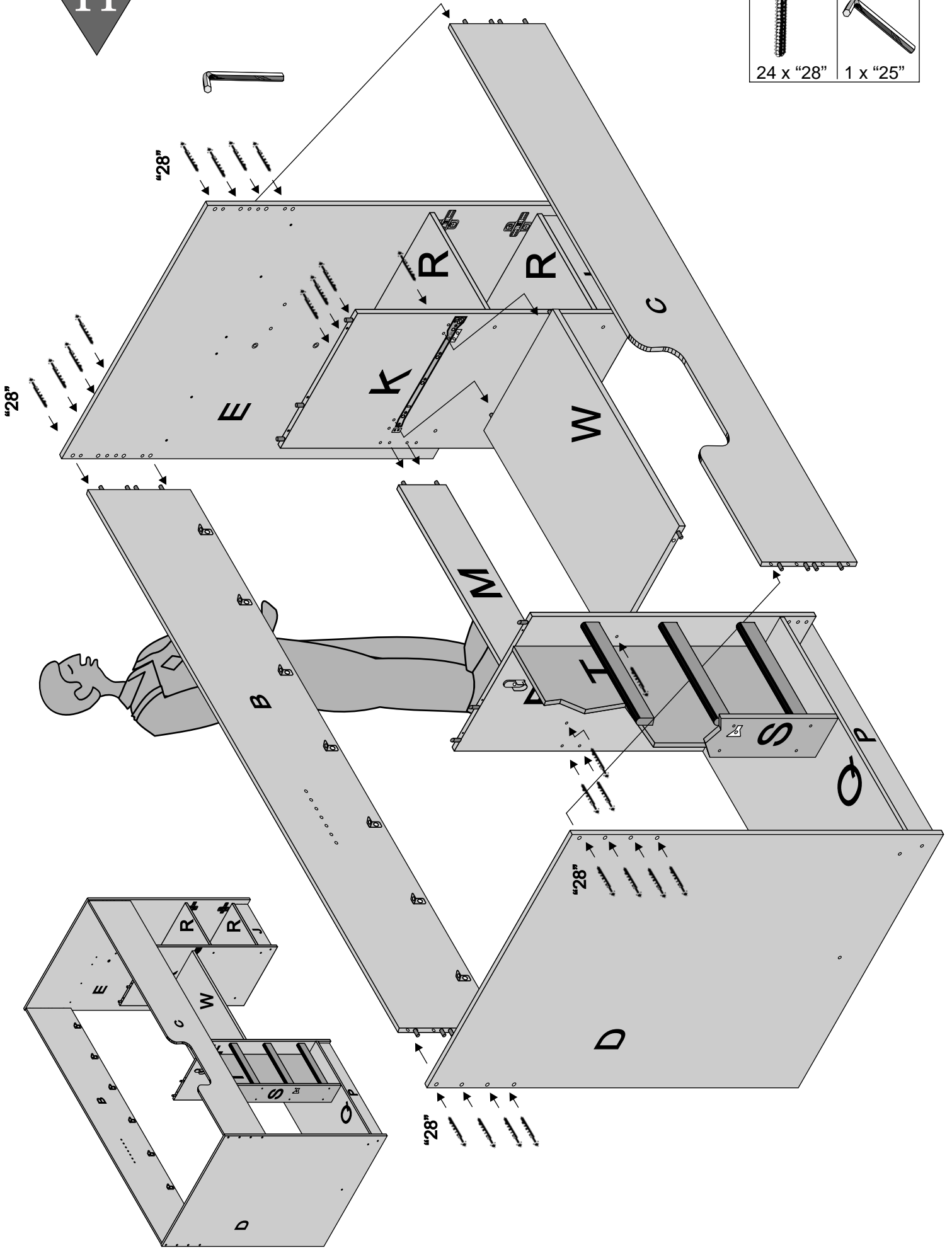
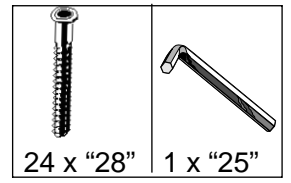

13

STEP 13 of 18 Cromer High Bed

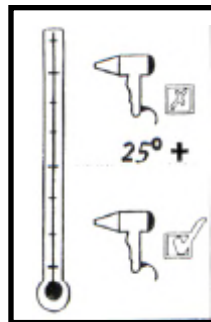
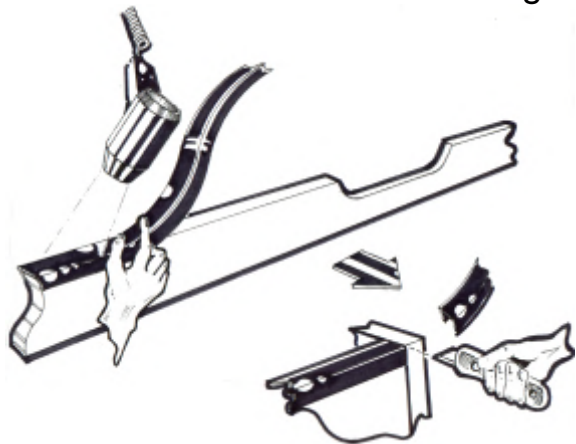

'534'	220cm	1
12mm	45mm	
26 x "43"	8 x "30"	

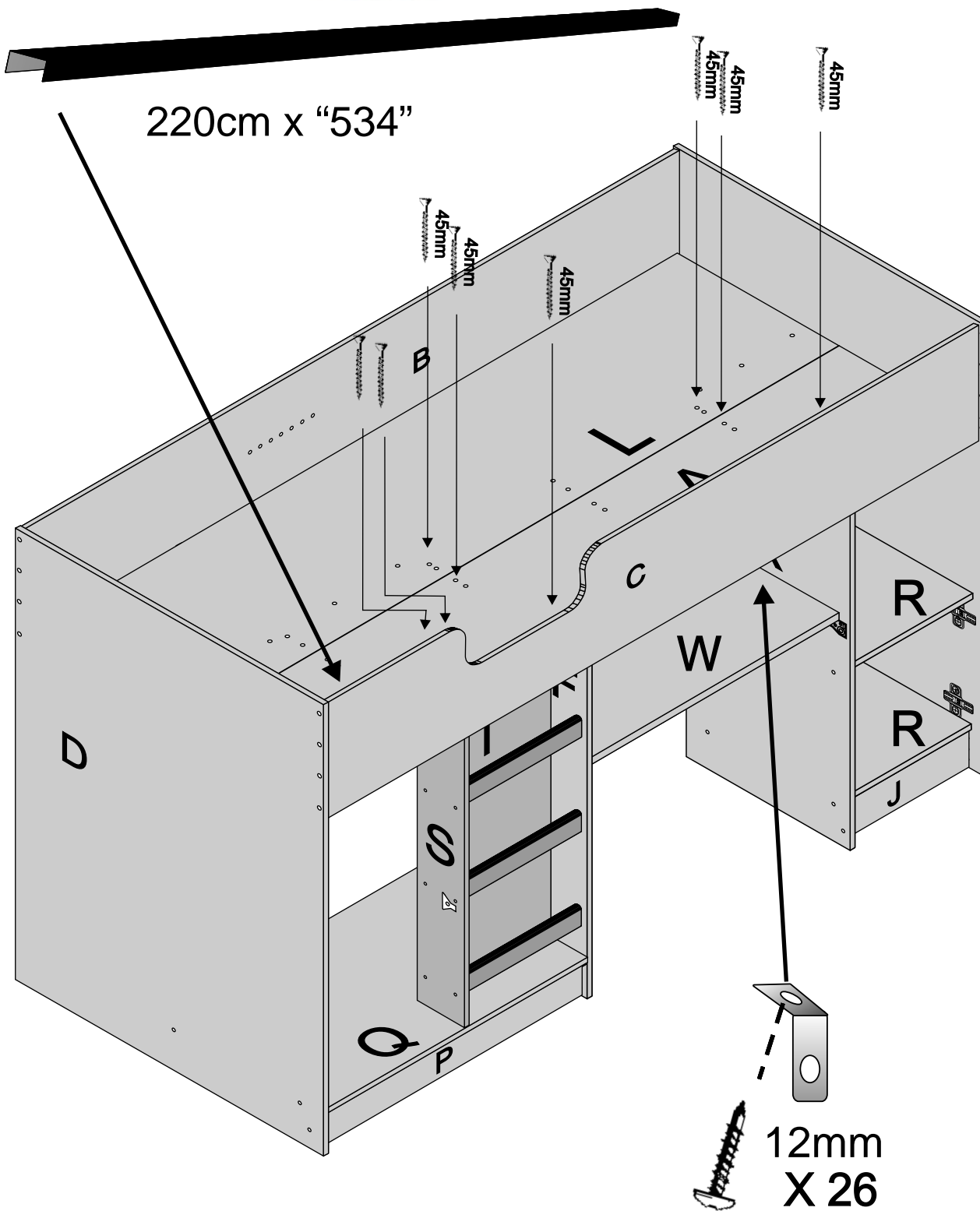





14

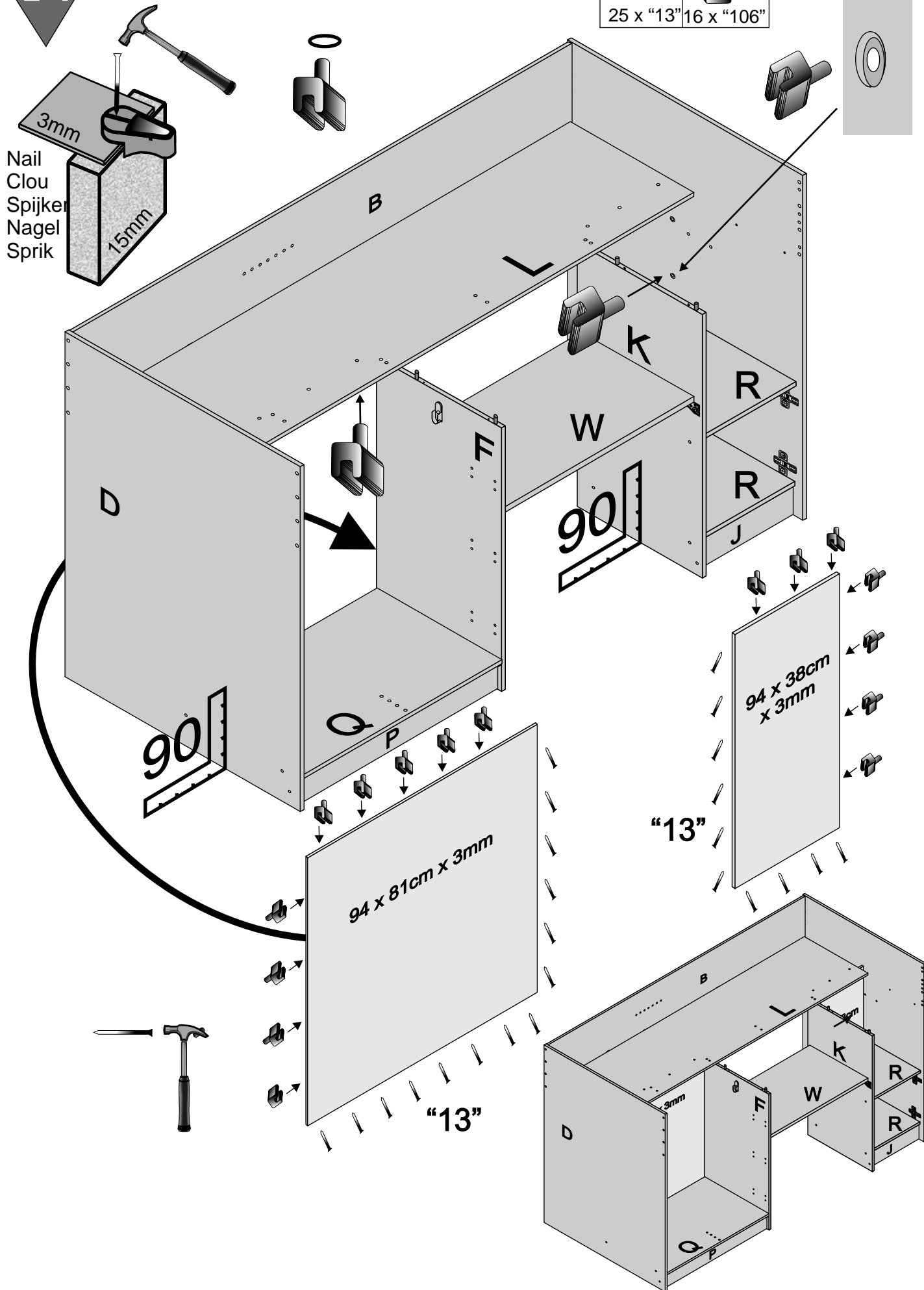

STEP 14 of 18 Cromer High Bed

25 x "13" 16 x "106"

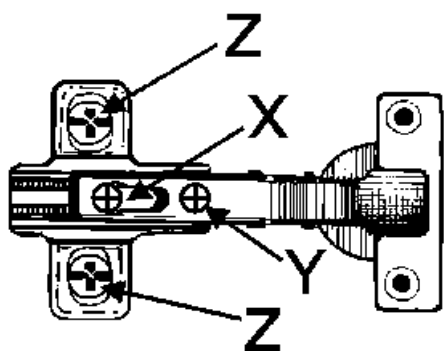
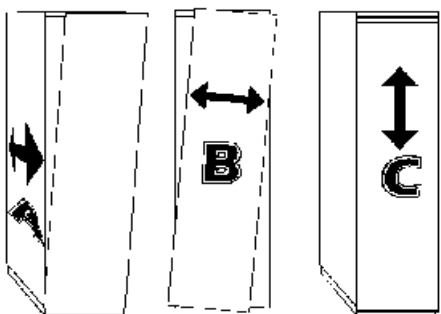
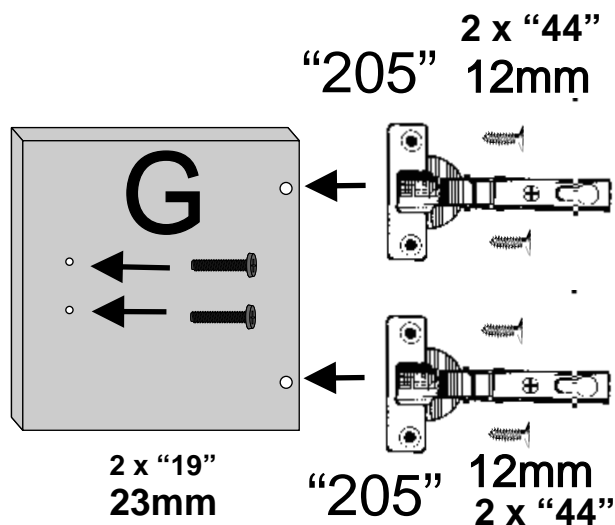
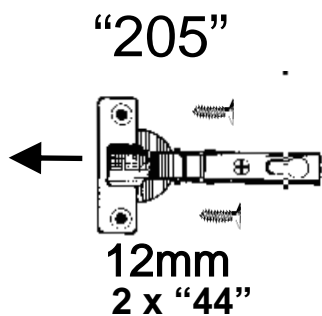
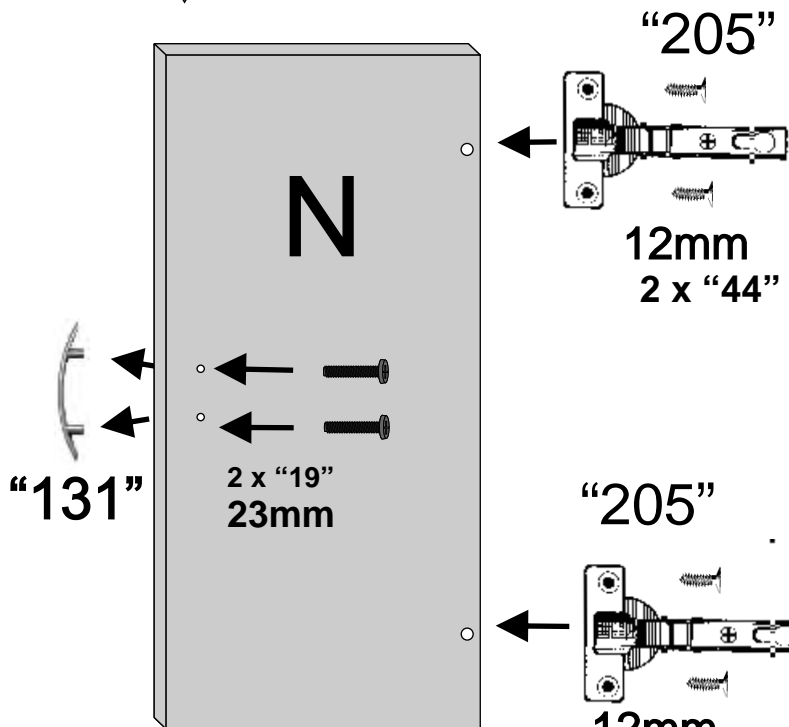

		'131'		2
8 x "44"	4 x "205"	'19'	 23mm	4



$X = A$ 
 $X + Y = B$ 
 $Z = C$ 

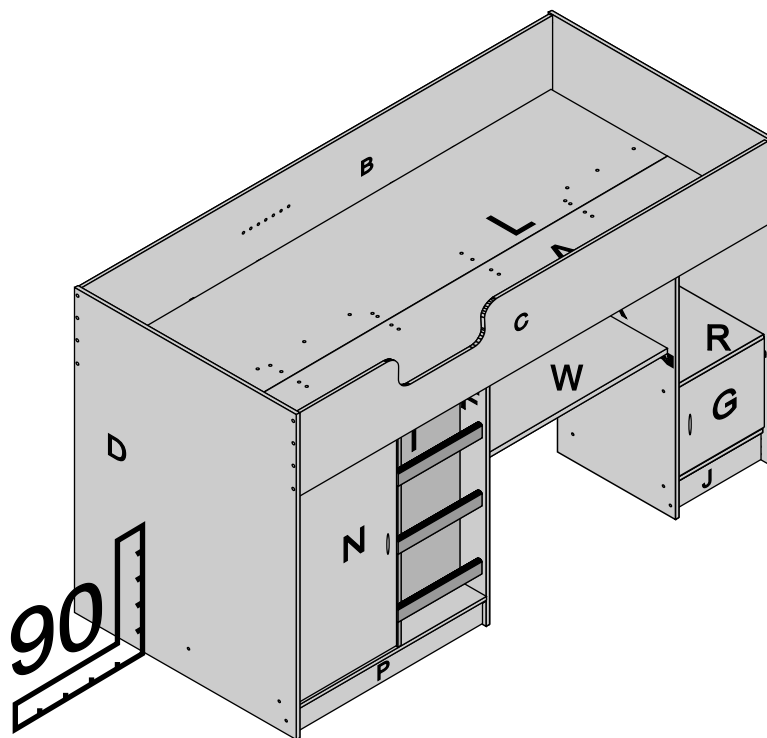

STEP 16 of 18 Cromer High Bed

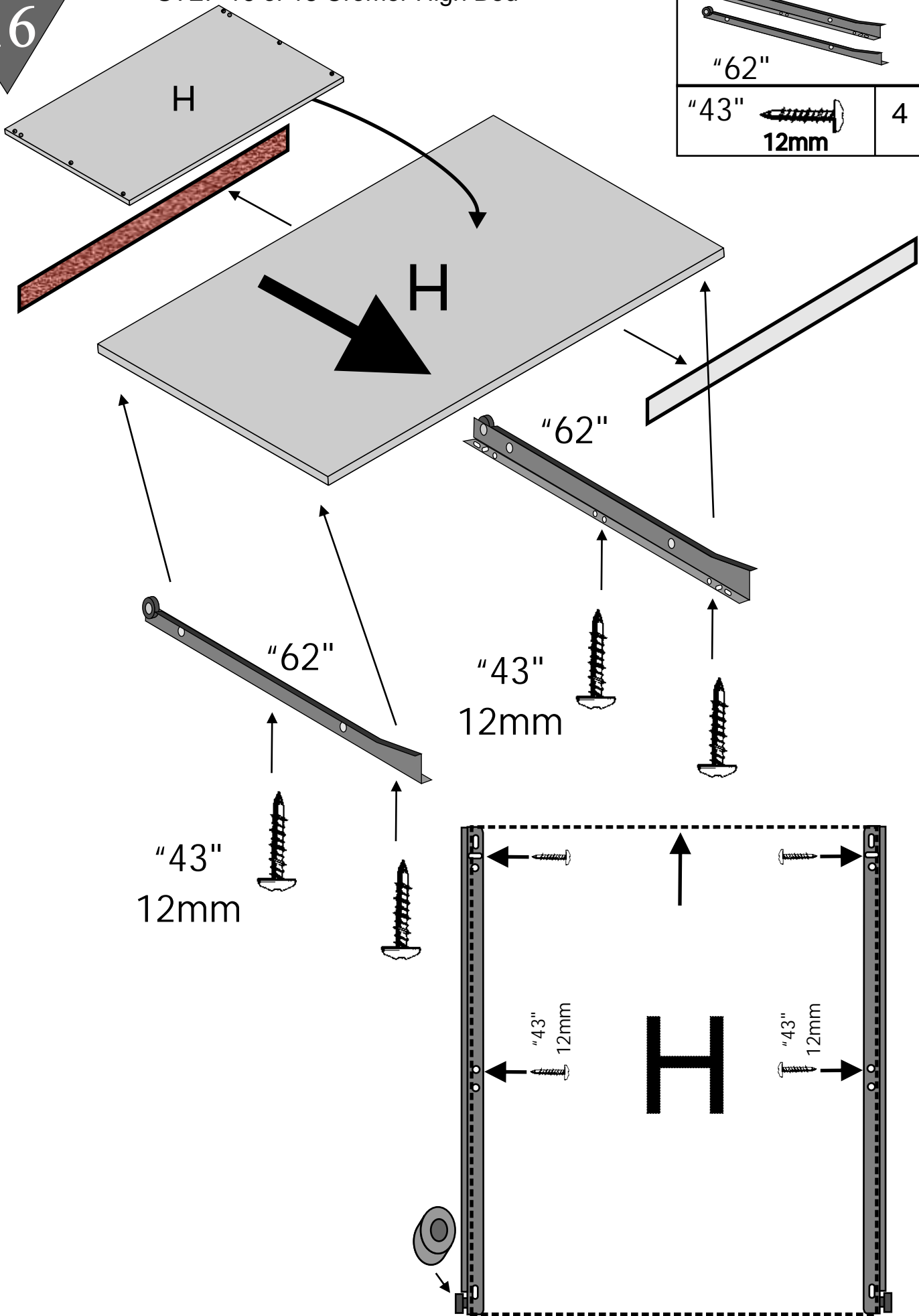

16

"62"	
"43" 12mm	4



17

STEP 17 of 18 Cromer High Bed

'125'	 79cm	1
'100'		4

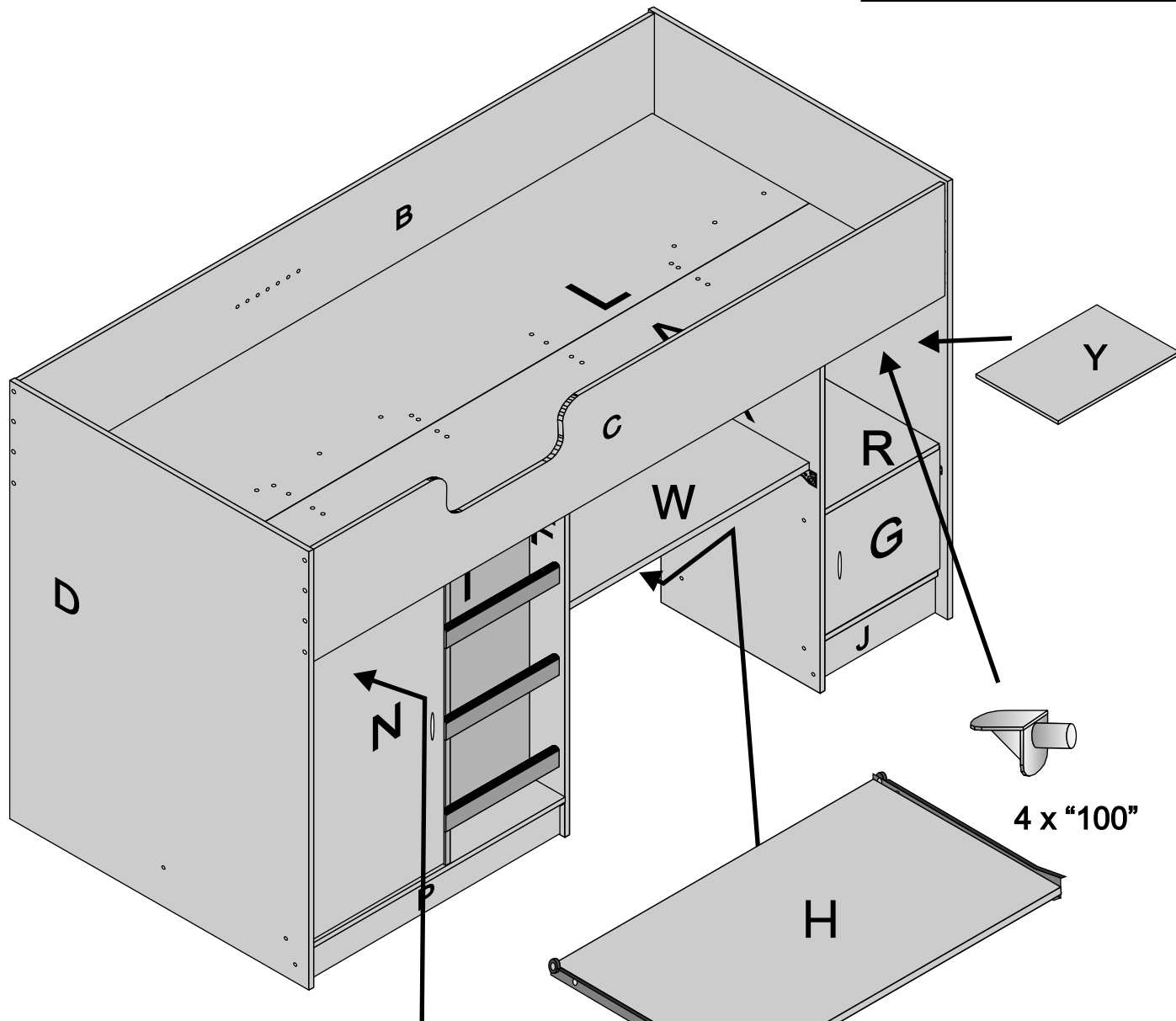

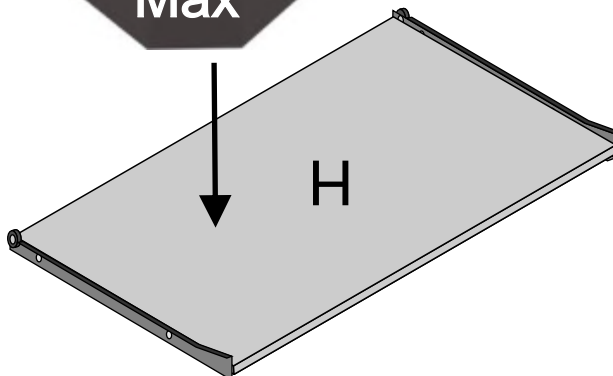

79cm x "125"

≥17kgs
Max



18

STEP 18 of 18 Cromer High Bed

"42"		4
"146" 27mm		2

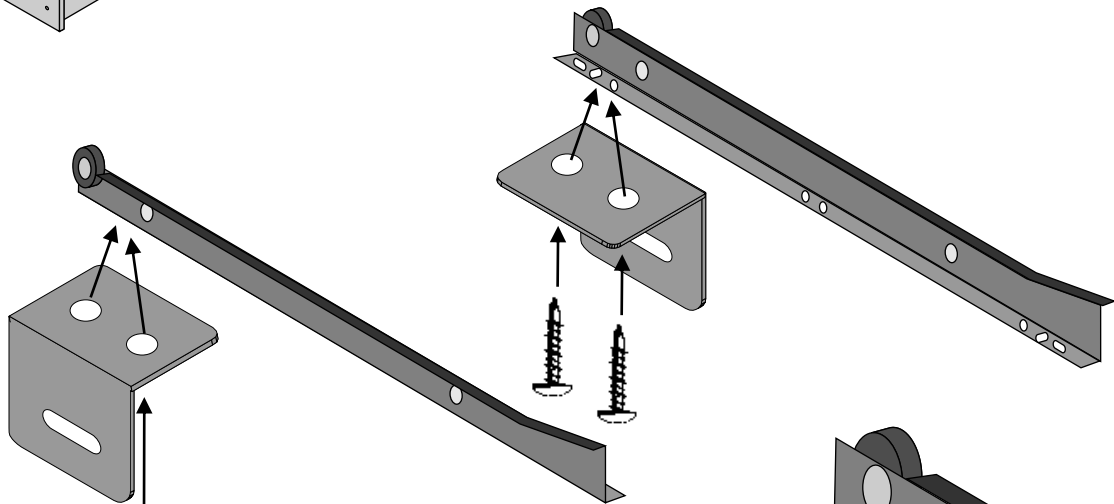
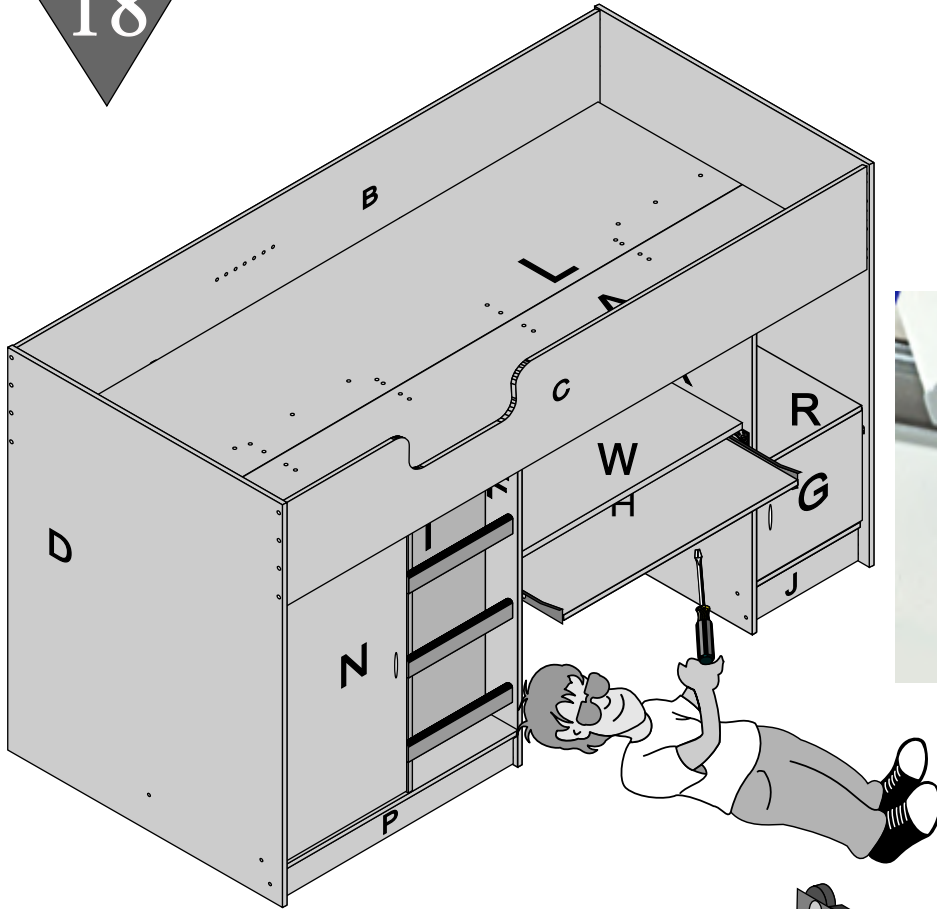

"42"
15mm

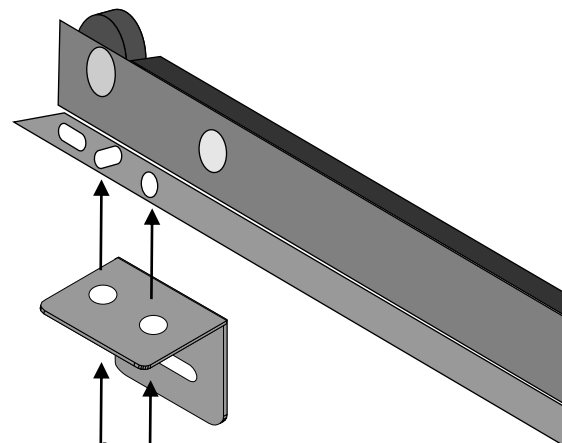

"42"
15mm

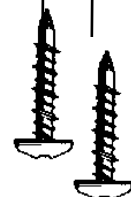

Belvoir Associates Ltd
 51 Pillings Road
 Oakham
 Rutland
 England
 LE15 6QF

UK Spares and Assembly HELPLINE 01572 755110
 Manufacturer - Belvoir Associates Ltd
 Pillings Road Oakham England