

Exeter Bed



- | | |
|--|--|
| D Montageanleitung
Bett Exeter | GB Assembly instructions
Bed Exeter |
| NL Montage-instructies
Bed Exeter | PL Instrukcje montazu
Łózko Exeter |
| TR Montaj talimatları
Yatak Exeter | RU Инструкция по монтажу
Bed Exeter |
| | F Instructions de montage
Lit Exeter |

Service • Assistenza • Dienstverlening • Servis
Servis • Szerviz • Сервисная служба

Name • Nom • Nome • Naam • Nazwa • Jméno • Názov • Név • Denumire • sim •	Exeter
Nr. • No. • N° • • Sz	
Typ • Type • Tip • Típus • Tipo •	

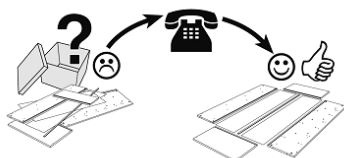
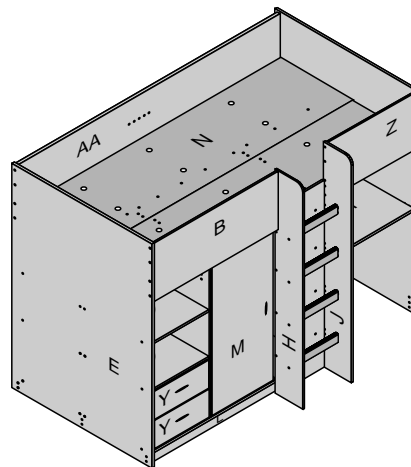

AA — 1	D — 2	G — 1	K — 1	N — 1	R — 1	AV — 1	
B — 1	E — 1	H — 1	L — 2	P — 1	AS — 1	Y — 2	
C — 1	F — 1	J — 1	M — 1	Q — 1	AT — 1	Z — 1	
1 x 109 x 71cm x 3mm		1 x 109 x 38cm x 3mm		1 x 66 x 47cm x 3mm		2 x 35 x 34cm x 3mm	

8 "23"	1 "190"	22 "44"	1 "25"	72 "28"	27 "13"	66 "43"	2x "222"
2 "205"	2 "206"	8 "18"	13 "106"	2 "118"	1 "151"	31 "155"	
8 "14"	16 "30"	8 "238"	4 X "47"	70 "104"	3 "131"	6 "19"	1 "120"
15 "156"	6x "74"	60 "220"	1 "17"	2 x "219"	4 "569"	1 "120"	
15 x "38"	8 "54"	2 x "165"	8x "78"	2 "63"			

EN 747-1:2012+A1:2015

3/12, 12/15, 23.07.21

0
10
20
30
40
50
60
70mm



Made by
Belvoir
Associates Ltd
Oakham
Rutland LE15 6QF
England

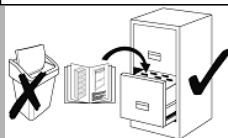
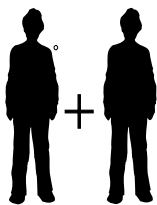

**WICHTIG - BITTE SORGFÄLTIG LESEN -
BEHALTEN FÜR ZUKÜNFTIGE VERWEIS
IMPORTANT - READ CAREFULLY - RETAIN FOR
FUTURE REFERENCE**

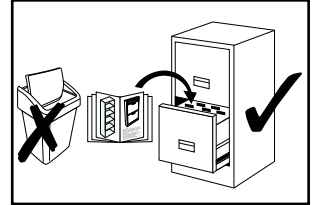

1. **WARNING;** High Beds and the upper beds of bunk beds are not suitable for children under six years of age due to the risk of injury from falls.
2. **WARNING;** Bunk beds and High beds can present a serious risk of injury from strangulation if not used correctly. Never attach or hang items to any part of the bunk bed or high bed that are not designed to be used with the bed, for example, but not limited to ropes, strings, cords, hooks, belts and bags.
3. **WARNING;** Children can become trapped between the bed and the wall, a roof pitch, the ceiling, adjoining pieces of furniture (e.g. Cupboards) and the like. To avoid risk of serious injury the distance between the top safety barrier and the adjoining structure shall not exceed 75 mm or shall be more than 230 mm.
4. **WARNING;** Do not use the bunk bed or high bed if any structural part is broken or missing.
5. Always follow the manufacturers instructions to assemble the bed.
6. The recommended size of mattress for this bed is 200 x 90 x 15cm.
7. The maximum mattress thickness is 15cm. The maximum height is marked on the back panel of the bed.
8. Ventilation of the room is necessary in order to keep the humidity low and to prevent mould in and around the bed.
9. All assembly fastenings, including screws, should be regularly checked to ensure they are properly tightened.
10. The bed is made to EN 747-1:2012+A1:2015 (E).

**WICHTIG - BITTE SORGFÄLTIG LESEN -
BEHALTEN FÜR ZUKÜNFTIGE VERWEIS
IMPORTANT - READ CAREFULLY - RETAIN FOR
FUTURE REFERENCE**

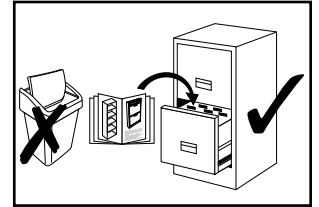

NL

1. **Waarschuwing: Hoogslapers en stapelbedden zijn niet geschikt voor kinderen jonger dan 6 jaar i.v.m. het risico van vallen.**
2. **Waarschuwing: Als het bed niet correct gebruikt wordt is er een verhoogd risico van letsel door verklemming of wurging. Verbind er daarom geen artikelen die geen deel uit maken van het bed zoals ondermeer ; touwen, riemen, koorden, haken en zakken aan .**
3. **Waarschuwing; Om te voorkomen dat kinderen tussen het bed en andere meubels of plafond of muur klem komen te zitten moeten de volgende afstanden tussen de veiligheidsbarriere en de aangrenzende structuur aangehouden worden. De afstand mag niet meer dan 75 mm maar moet meer dan 230mm zijn.**
4. **Waarschuwing; Gebruik het stapelbed of de hoogslaper niet als een structureel onderdeel ontbreekt of gebroken is.**
5. **Bouw het meubel volgens de instructies van de fabricant.**
6. **Aanbevolen matrasmaat 200x90x15cm .**
7. **Maximum matras dikte 15cm. De maximale hoogte is duidelijk op de rug paneel van het bed.**
8. **Ventileer de kamer om schimmel en vocht vorming te voorkomen .**
9. **Alle montage bevestigingen zoals schroeven moeten regelmatig worden gecontroleerd om ervoor te zorgen dat ze goed zijn vastgedraaid.**
10. **Het bed voldoet aan EN 747-1:2012+A1:2015**

F

1. **MISE EN GARDE; Les lits mezzanine et les lits du haut dans les lits superposés ne conviennent pas à des enfants de moins de 6 ans en raison des risques du chute.**
2. **MISE EN GARDE; Si on ne respecte pas les consignes d'utilisation, on peut s'exposer à un sérieux risque de strangulation.**
Il ne faut jamais attacher ou pendre à aucune partie du lit superposé ou du lit mezzanine un élément qui ne soit pas conçu pour être utilisé avec lit, comme, par exemple, des cordes, des ficelles, des cordons, des crochets, des ceintures et des sacs, la liste n'étant pas exhaustive.
3. **MISE EN GARDE; Les enfants peuvent se retrouver coincés entre le lit d'une part et d'autre part le mur, la pente du toit, le plafond, les meubles attenants et autre elements semblables. Pour éviter tout risque de blessure grave, la distance entre la barrière de sécurité du haut et la structure attenante devra faire moins de 75mm ou plus de 230mm.**
4. **MISE EN GARDE; Ne pas utiliser le lit superposé ou le lit mezzanine si un élément de la structure est cassé ou manquant.**
5. **Toujours suivre les instructions du fabricant pour assembler le lit.**
6. **Pour ce lit il est recommandé d'utiliser un matelas 1 personne (200 x 90 x 15cm).**
7. **L'épaisseur du matelas ne doit pas dépasser 15cm. La hauteur maximale est marqué sur le dos panneau du lit**
8. **Il est nécessaire de bien ventiler la chambre pour réduire au maximum le taux d'humidité et empêcher tout risque de moisissure a l'intérieur et autour du lit.**
9. **Tous les éléments permettant la bonne tenue de l'assemblage, y compris les vis, doivent être régulièrement inspectés pour s'assurer qu'ils sont correctement vissés.**
10. **Le lit respecte les normes Europeennes EN 747-1:2012+A1:2015**

Exeter High Bed

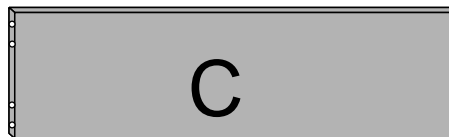
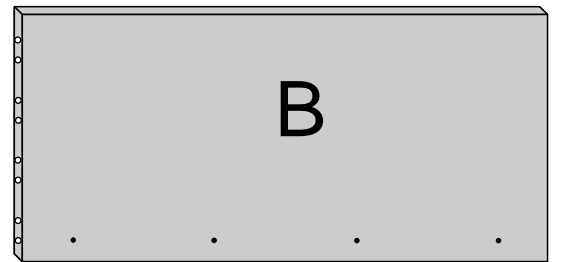
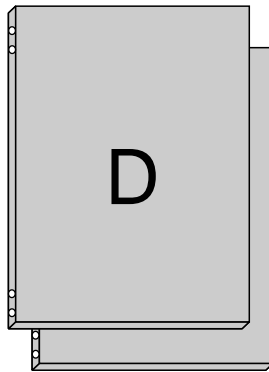
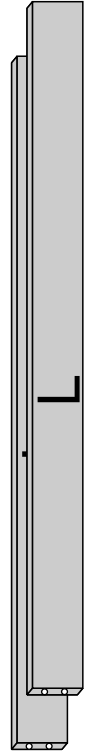
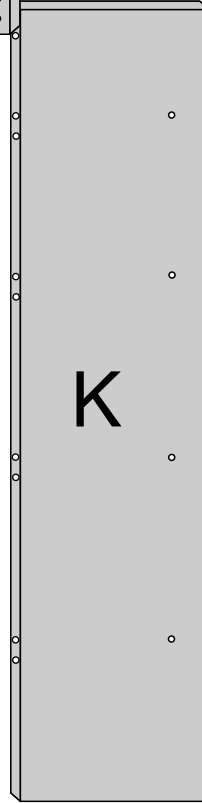
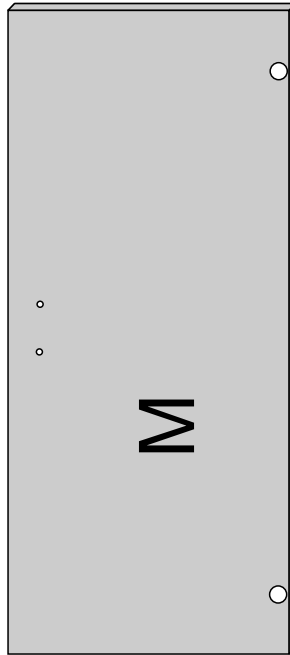
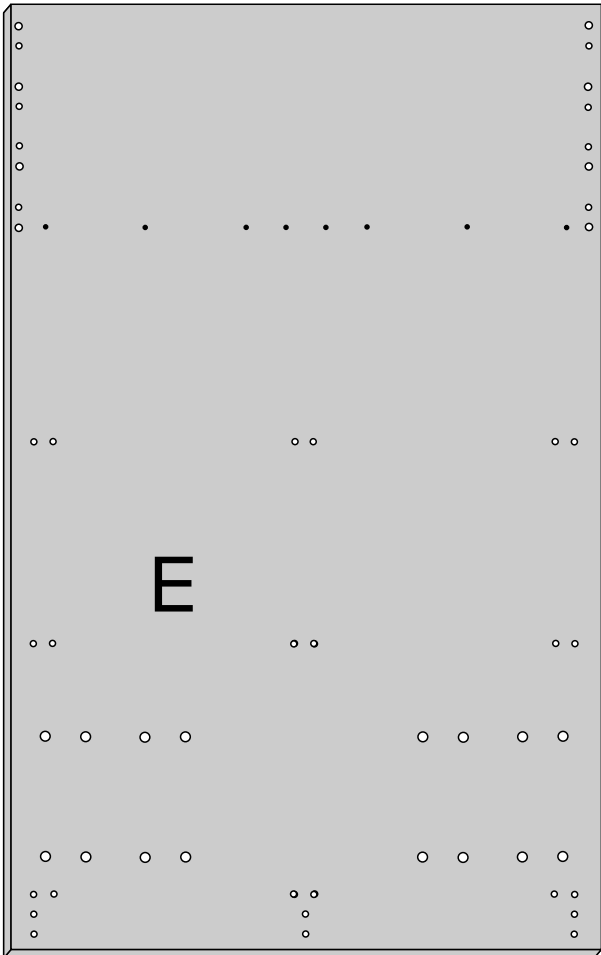
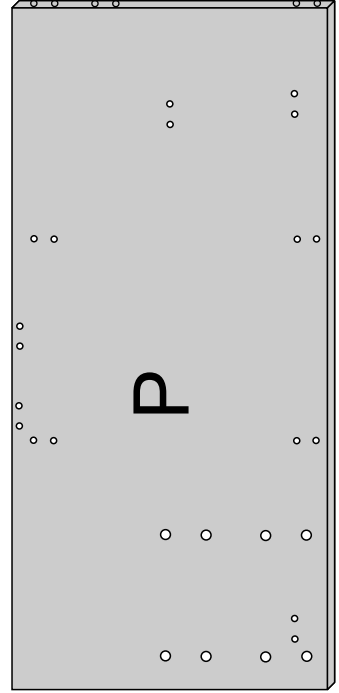
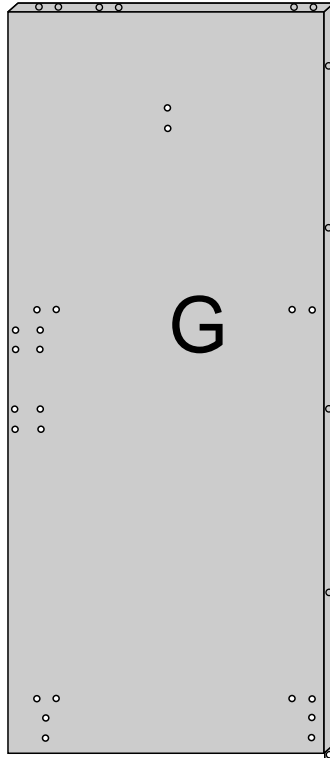
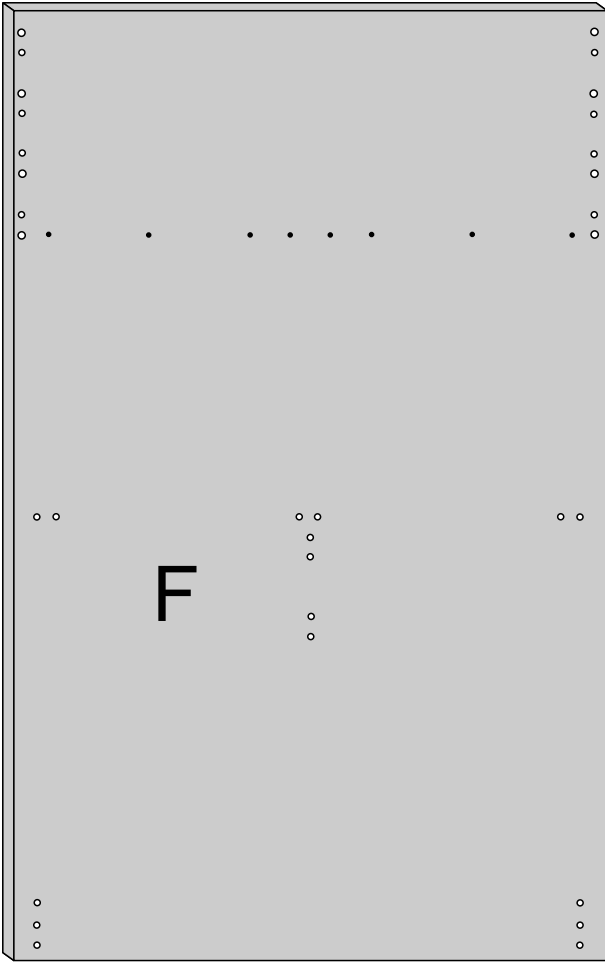

Exeter High Bed

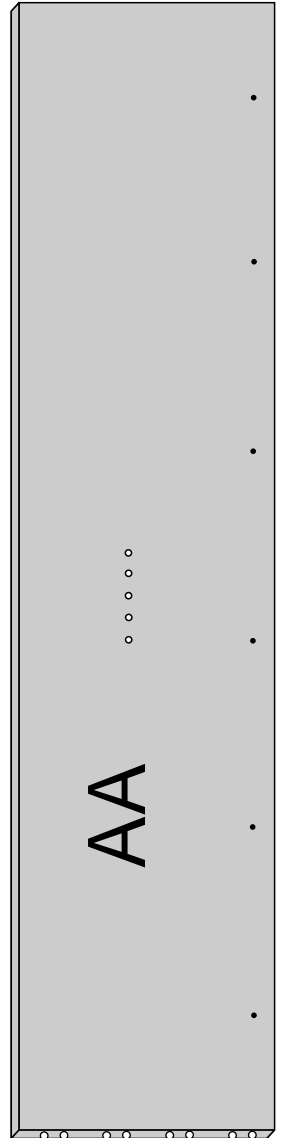
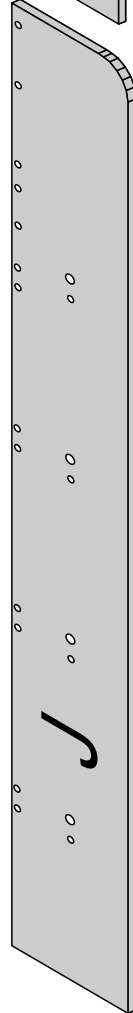
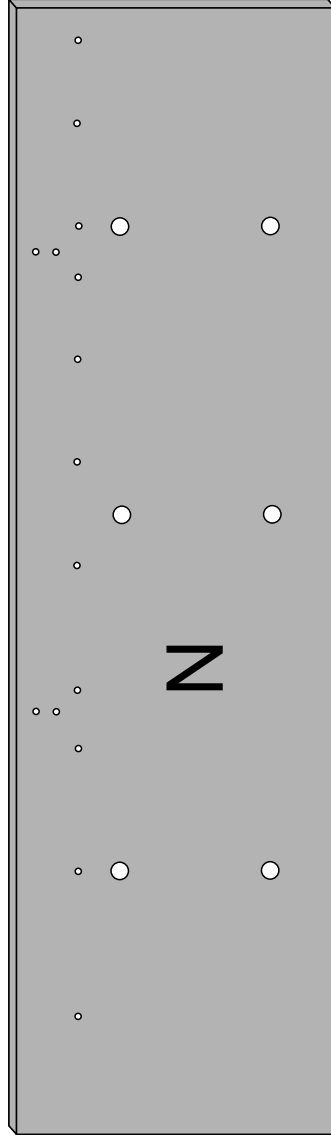
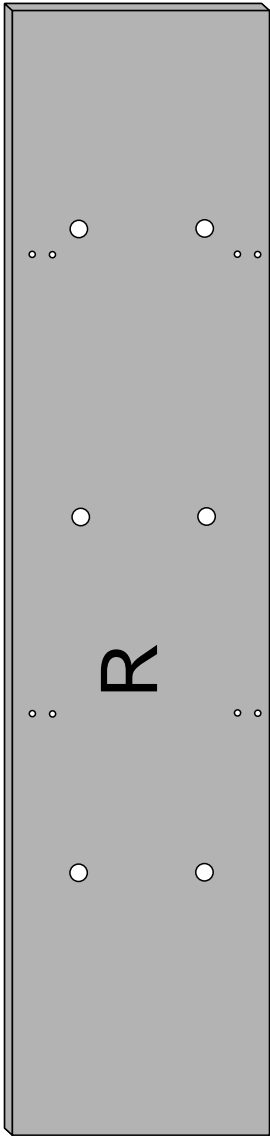
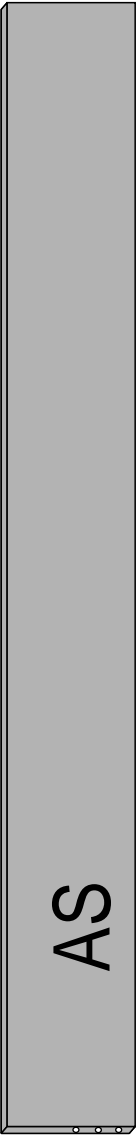
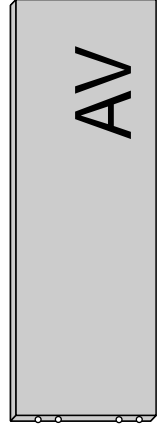
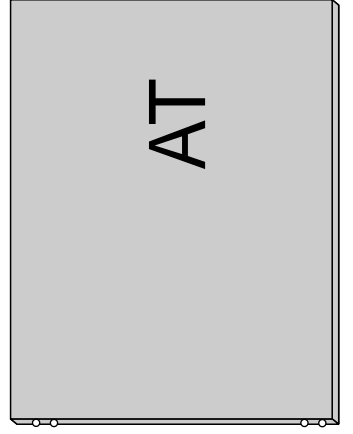
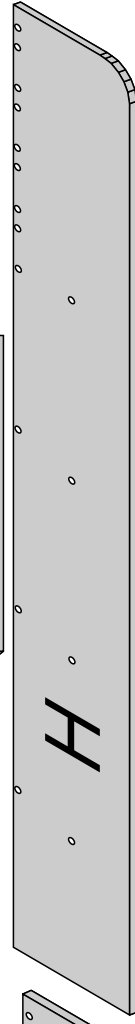
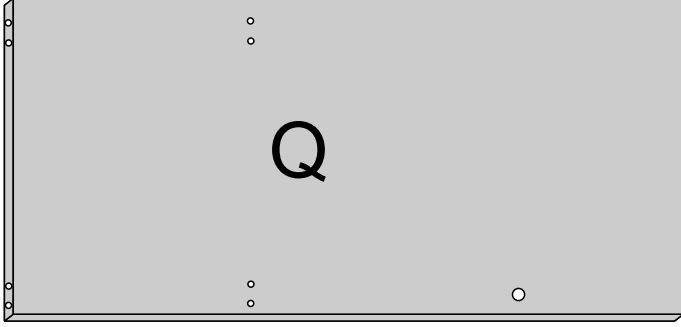
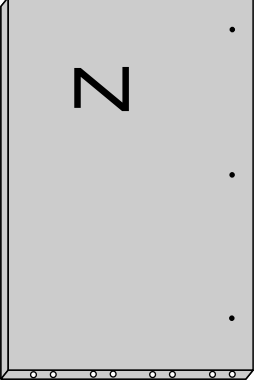
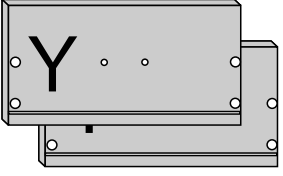

1



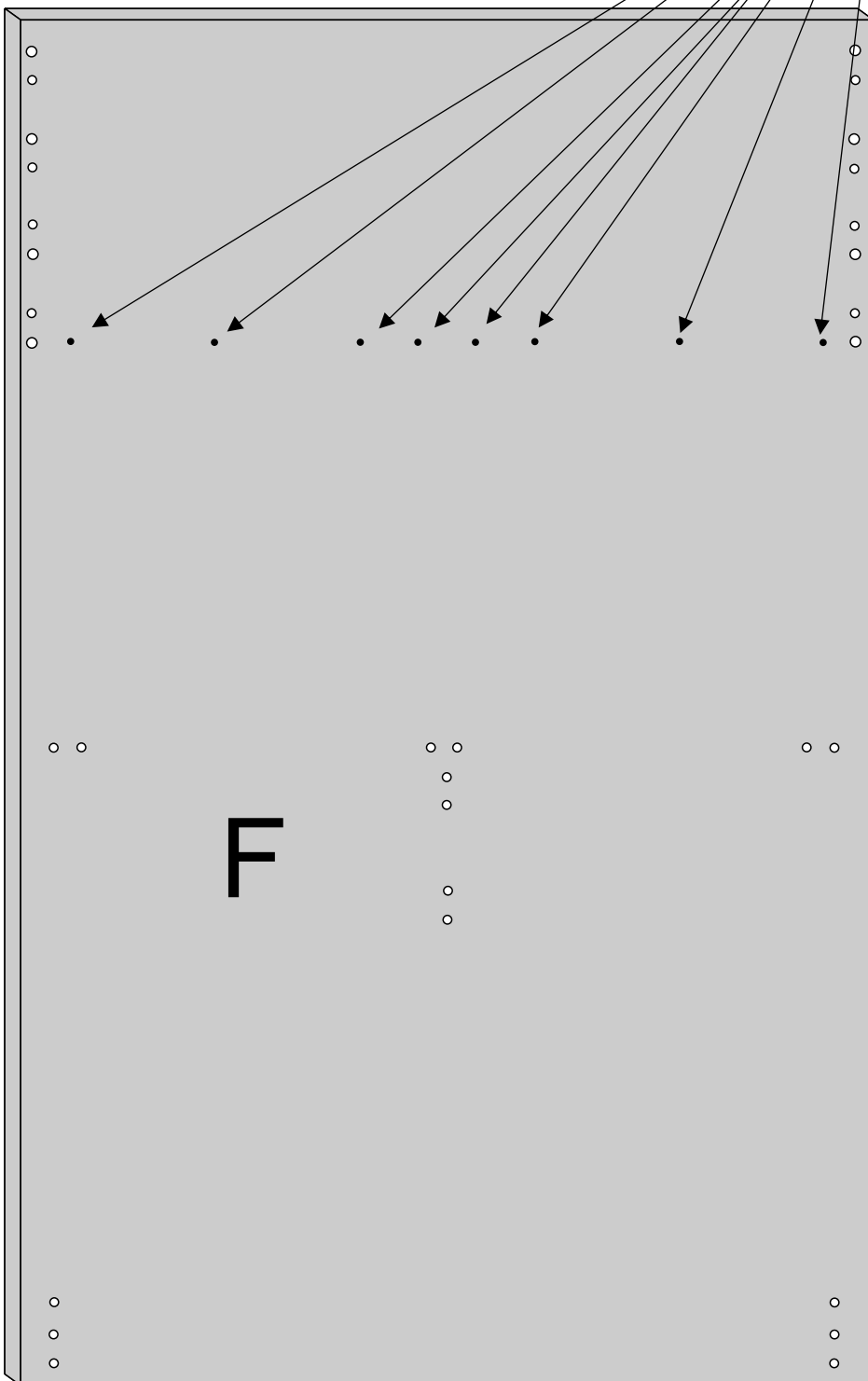
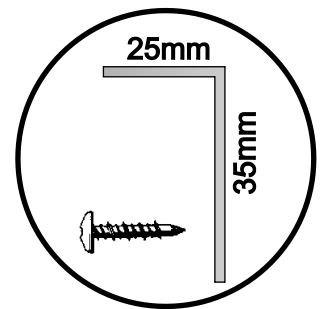
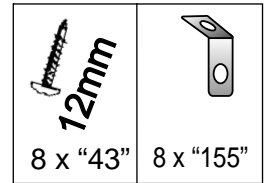
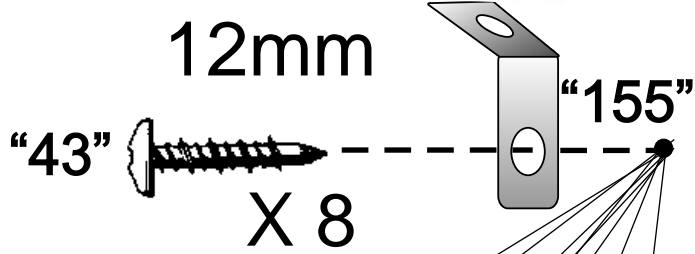
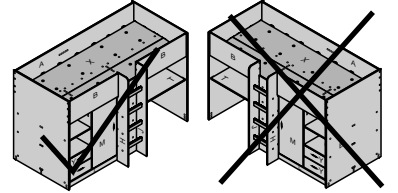
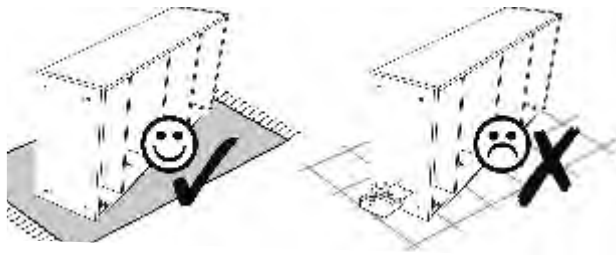

STEP 1 of 24 Exeter High Bed

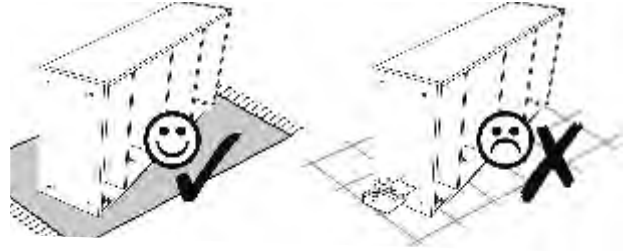
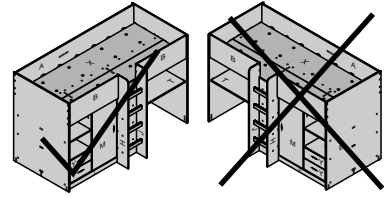

2

STEP 2 of 24 Exeter High Bed



 12mm 8 x "43"	 8 x "155"	 8 x "44"	 2 x "63"
---	--	---	---

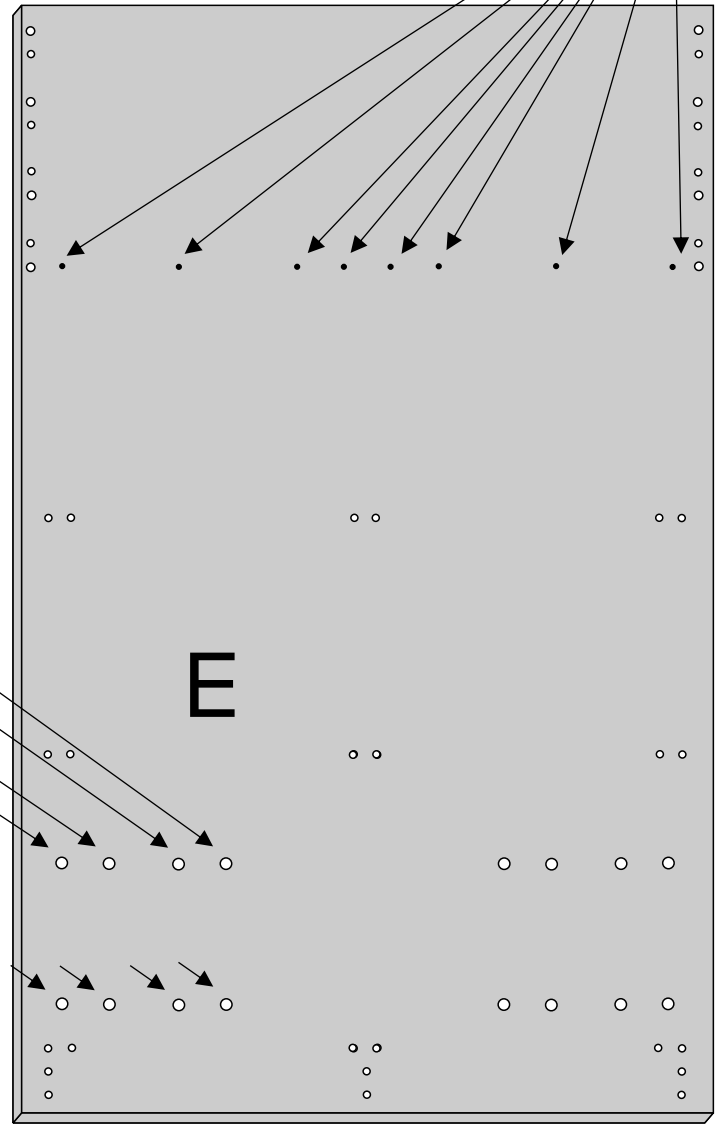
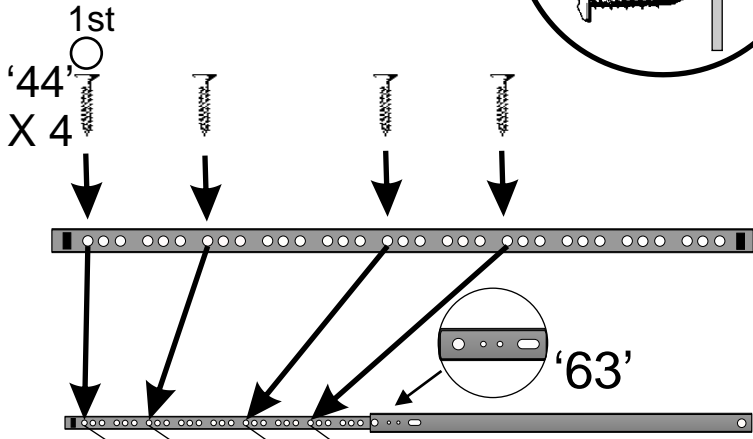
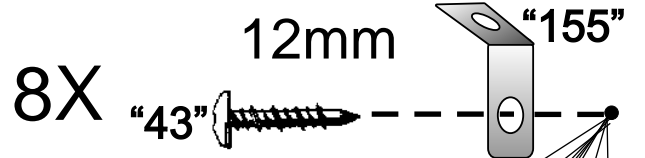
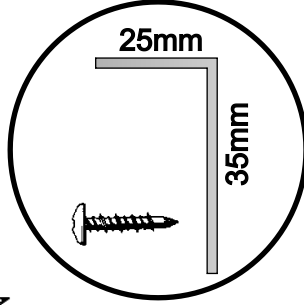

3

STEP 3 of 24 Exeter High Bed

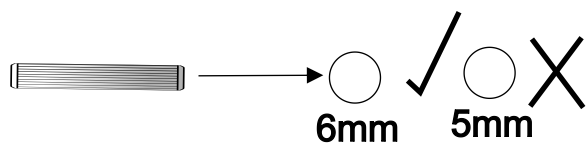
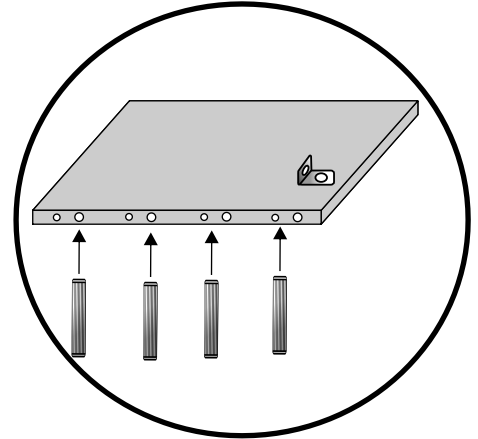
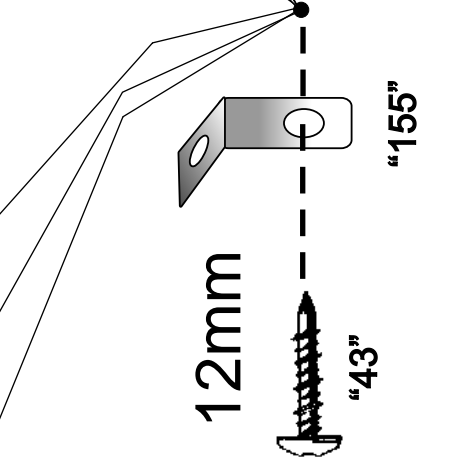
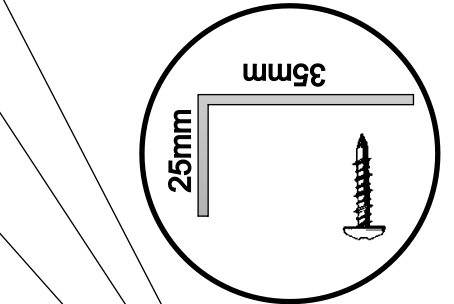
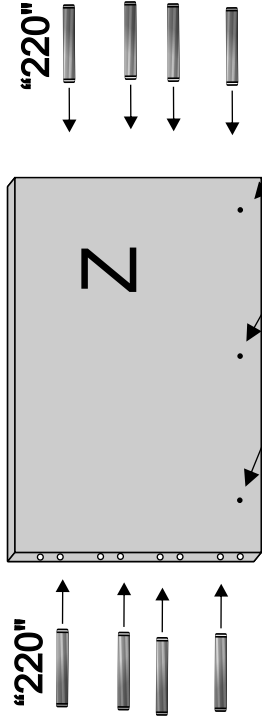
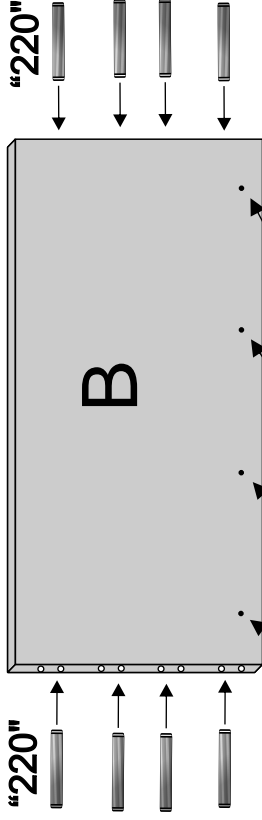
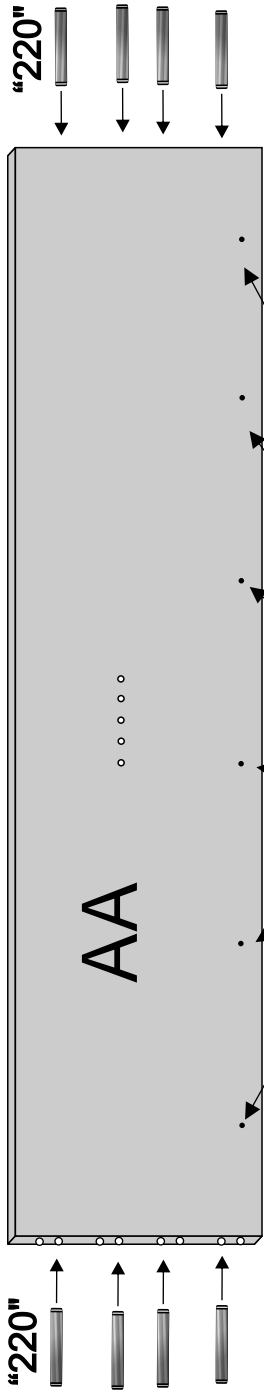
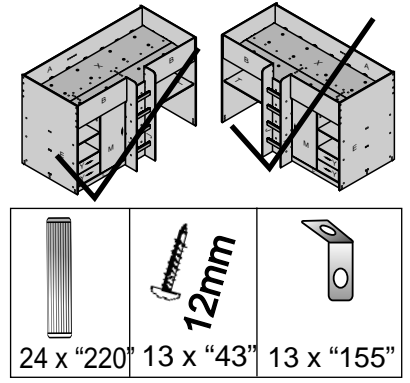

4

STEP 4 of 24 Exeter High Bed

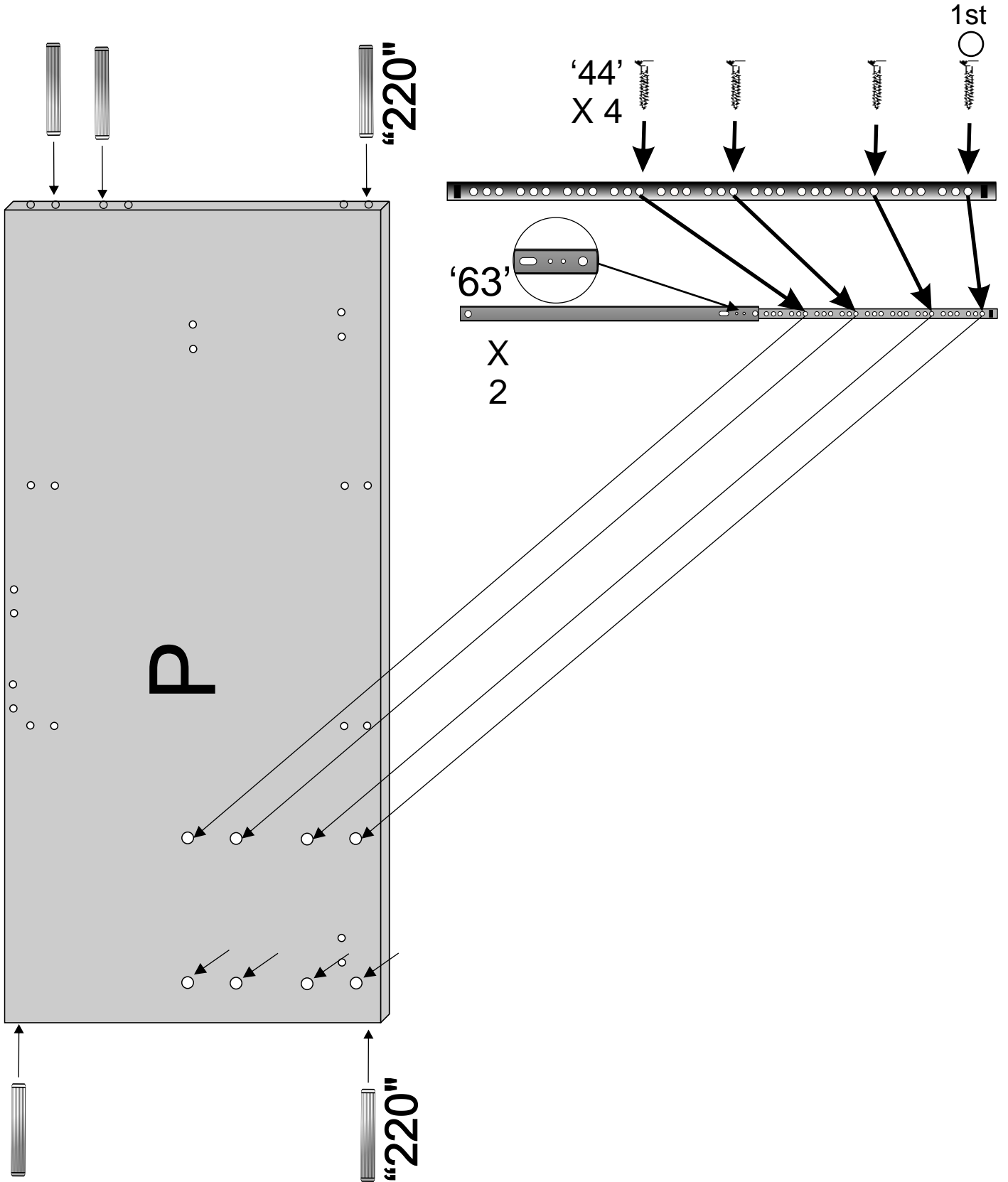
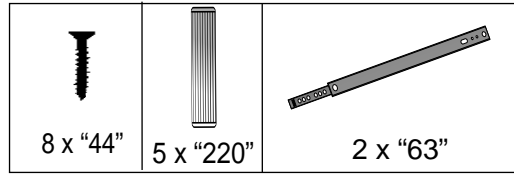
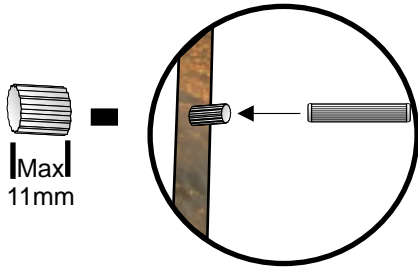
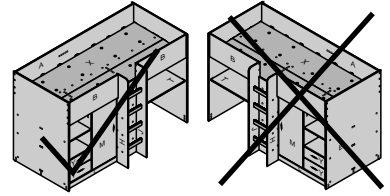

5

STEP 5 of 24 Exeter High Bed

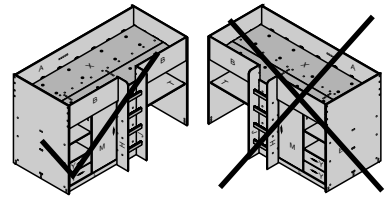

			
4 x "220"	1 x "44"	1 x "118"	2 x "206"

1 x 12mm

"44"





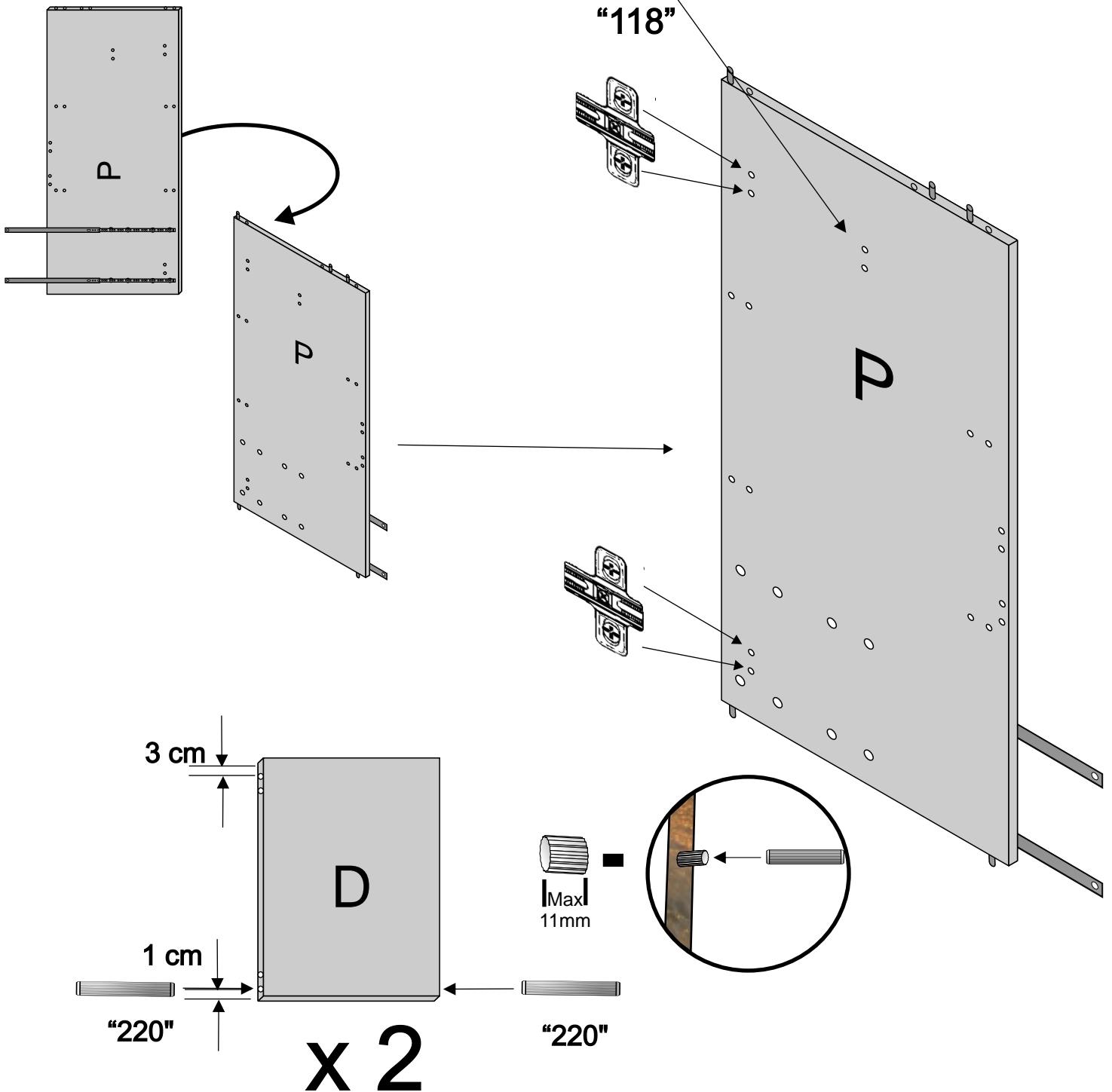

"118"

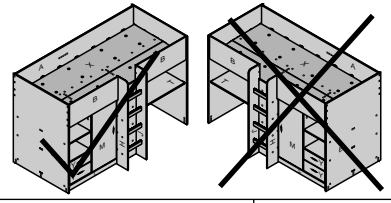

6

STEP 6 of 24 Exeter High Bed



 5 x "220"	 12mm 1 x "44"	 1 x "118"
--	---	--

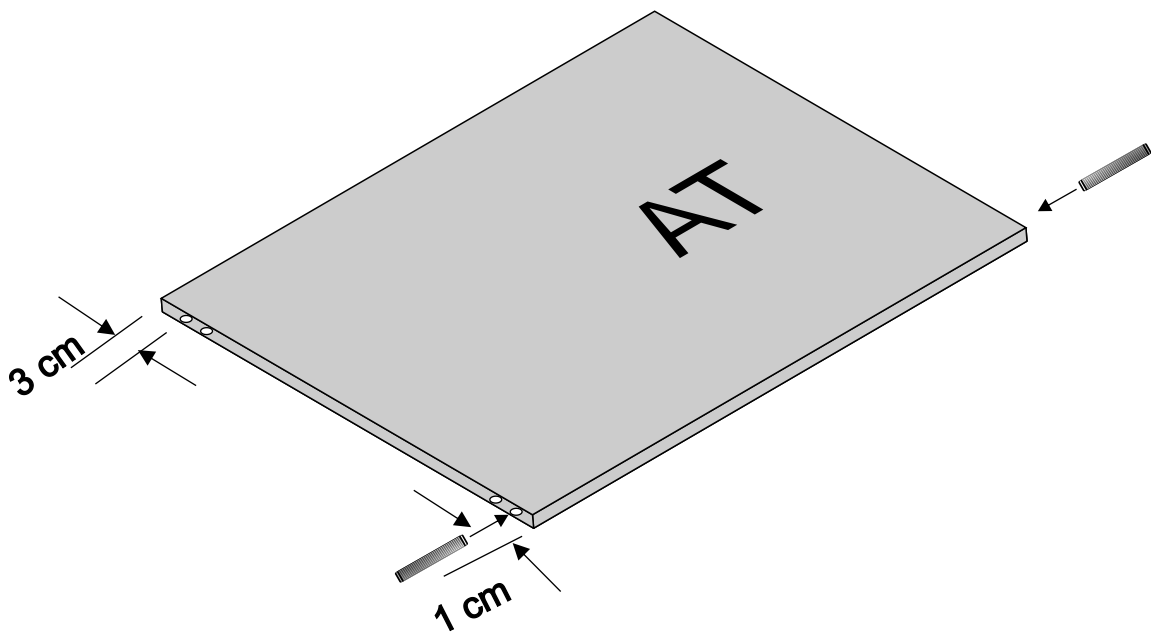
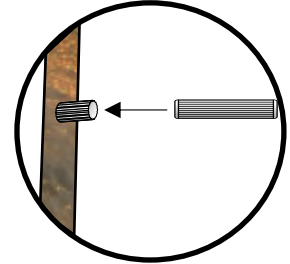
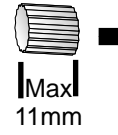
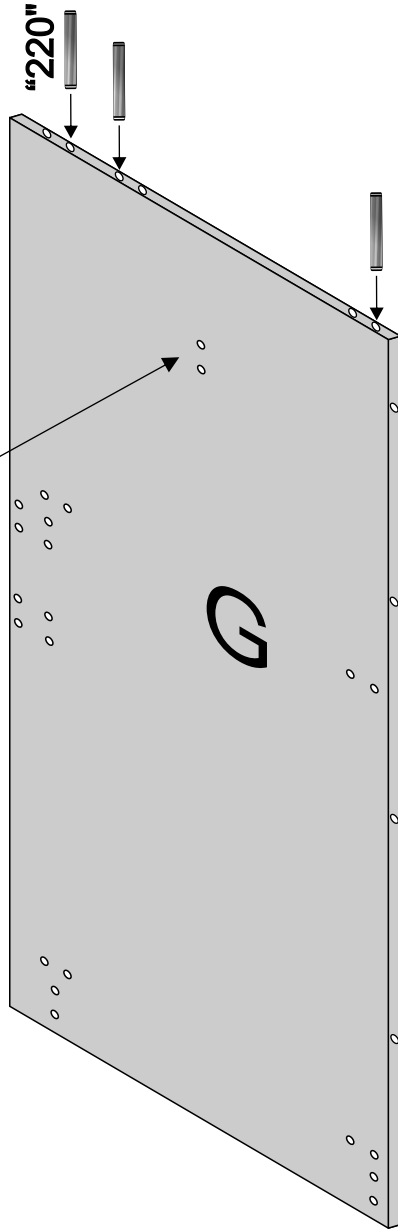

7

STEP 7 of 24 Exeter High Bed

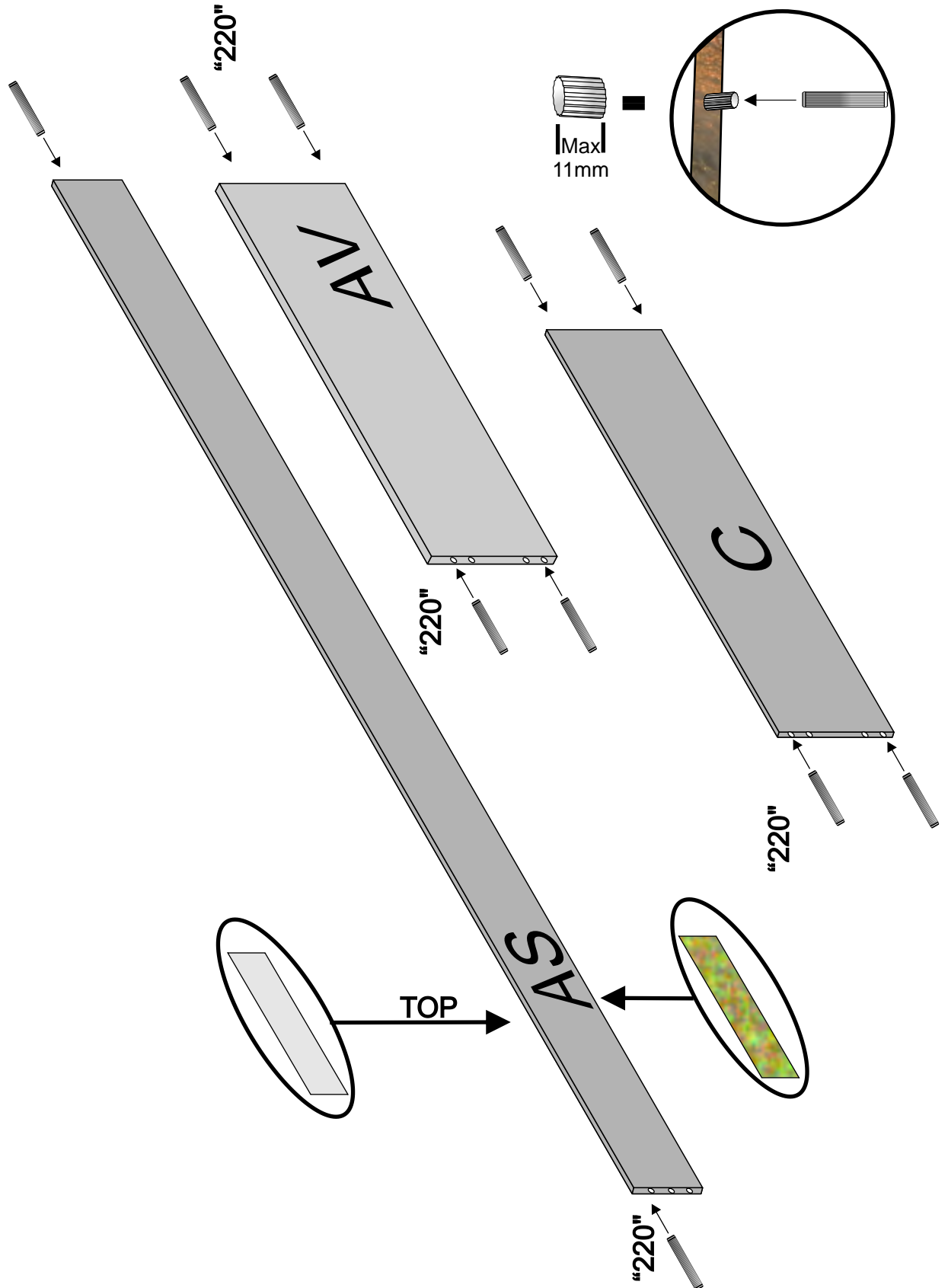
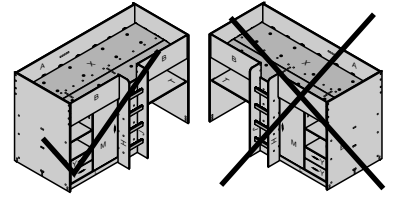
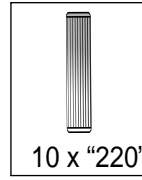

8

STEP 8 of 24 Exeter High Bed

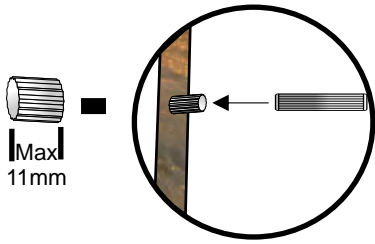
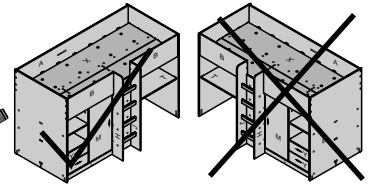

"220"

4 x

"238"

8 x "23"

K

12 x "220"

1 x "190"

8 x "23"

8 x "238"

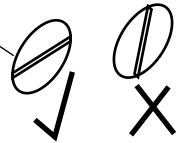

"188"

"220"

Q

9

STEP 9 of 24 Exeter High Bed

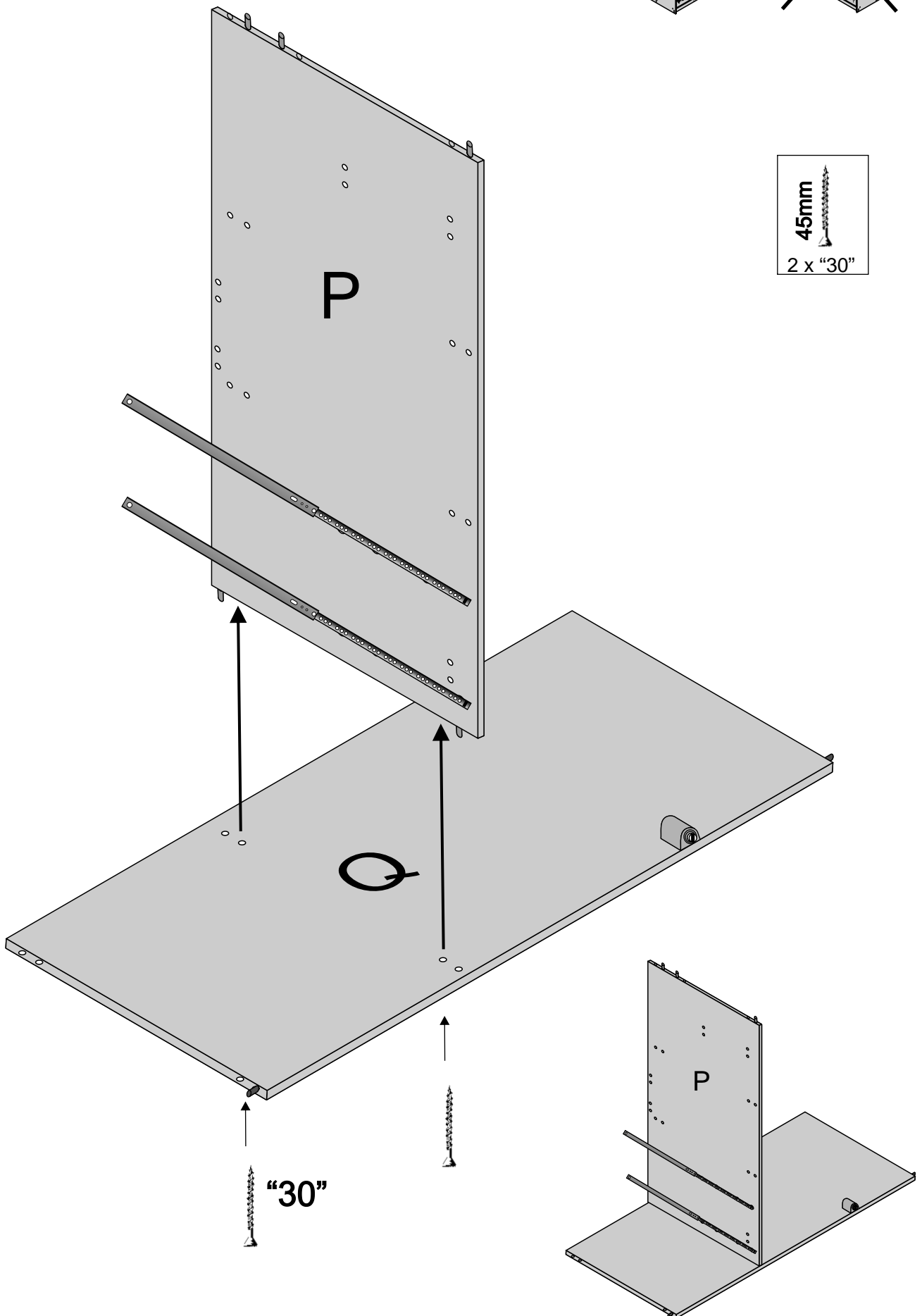
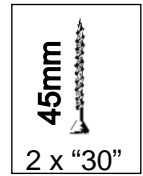
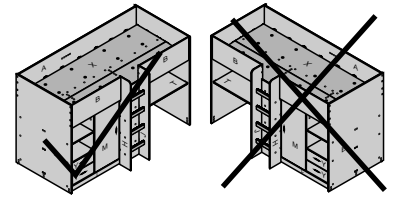

10

STEP 10 of 24 Exeter High Bed

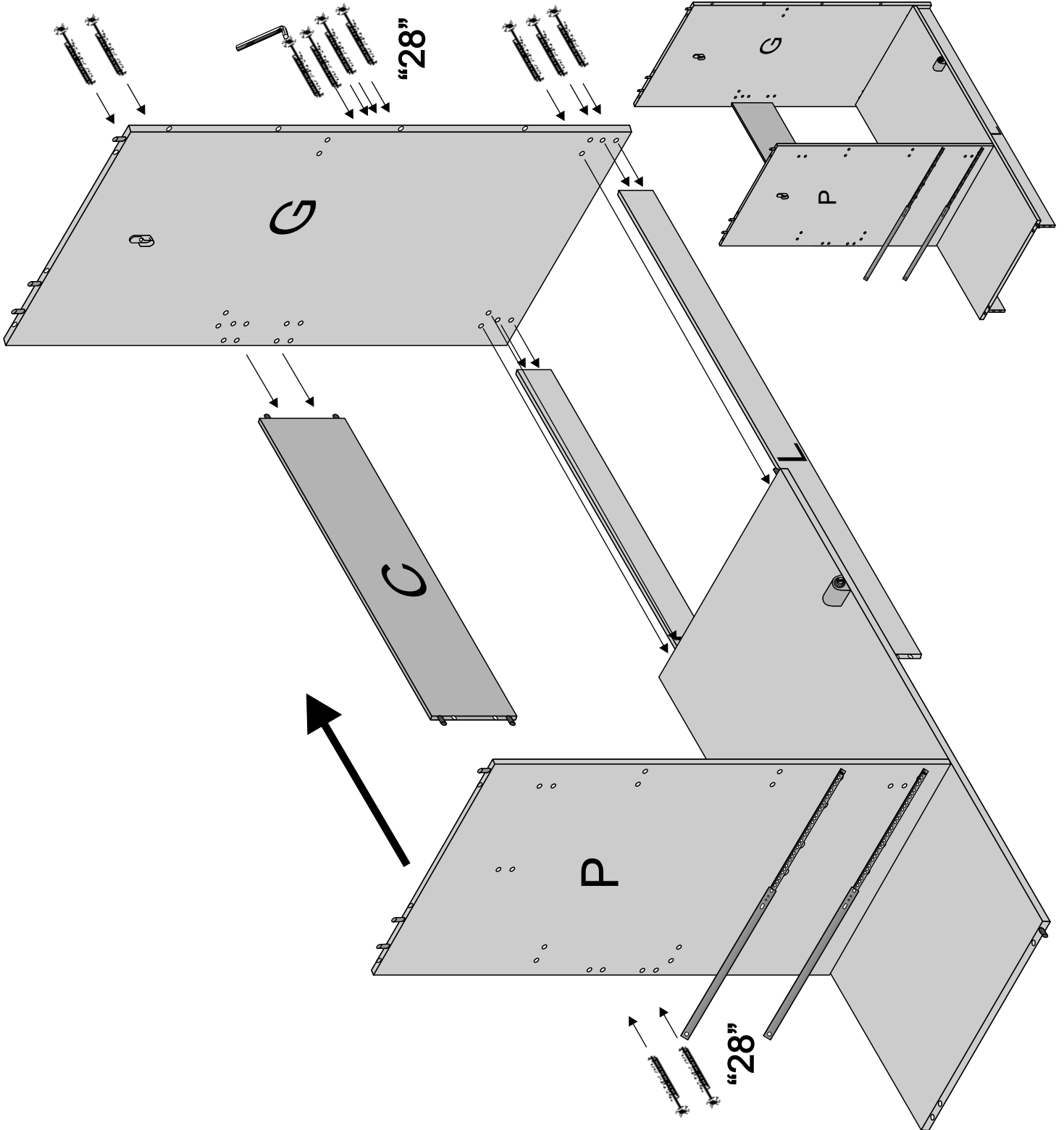
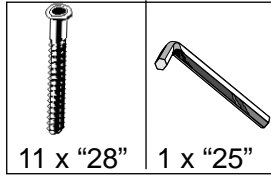
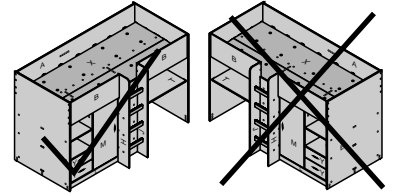

11

STEP 11 of 24 Exeter High Bed

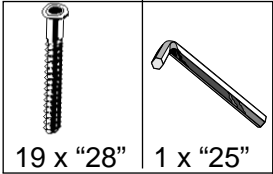
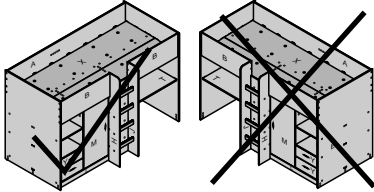

19 x "28"

1 x "25"

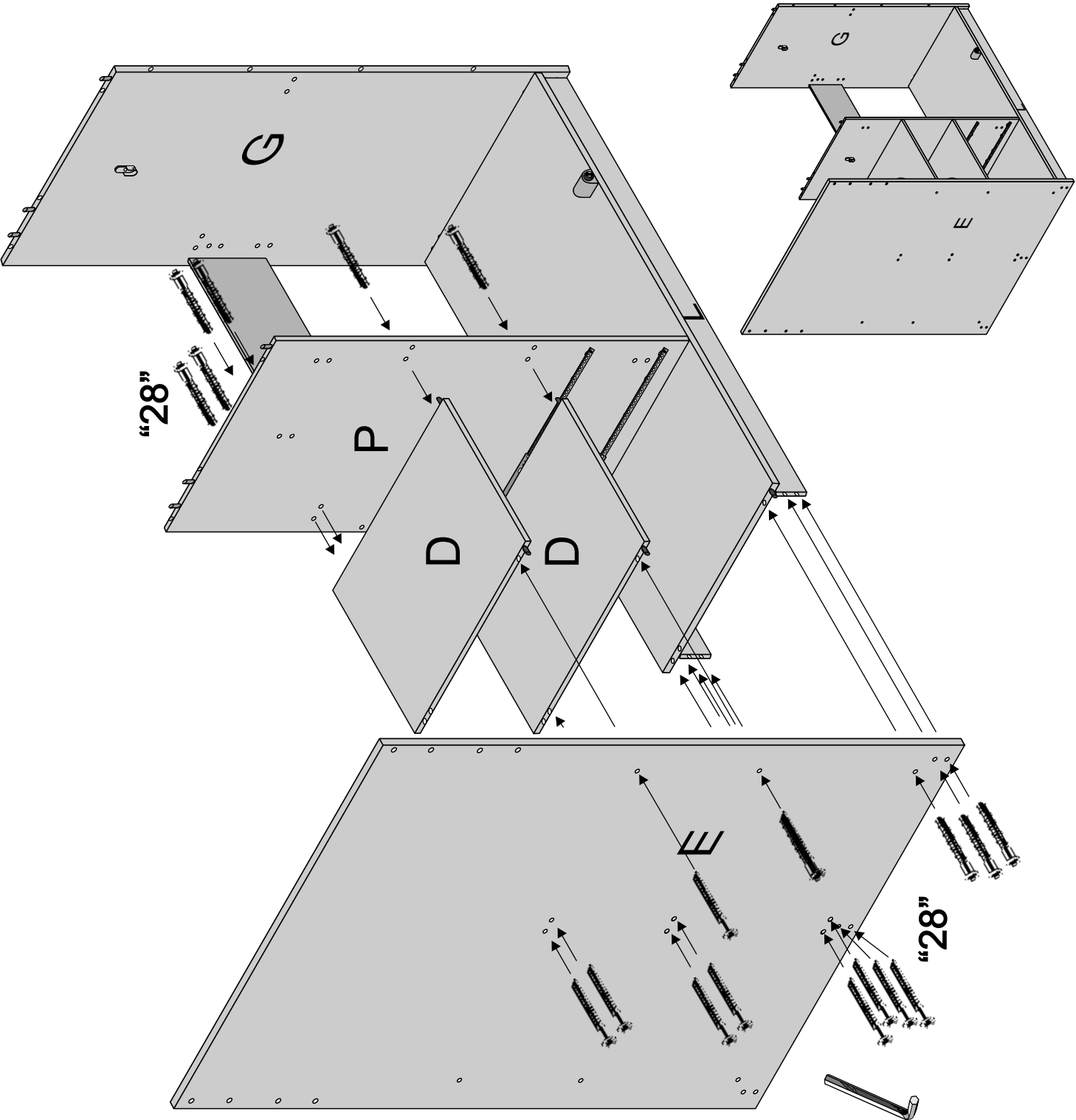

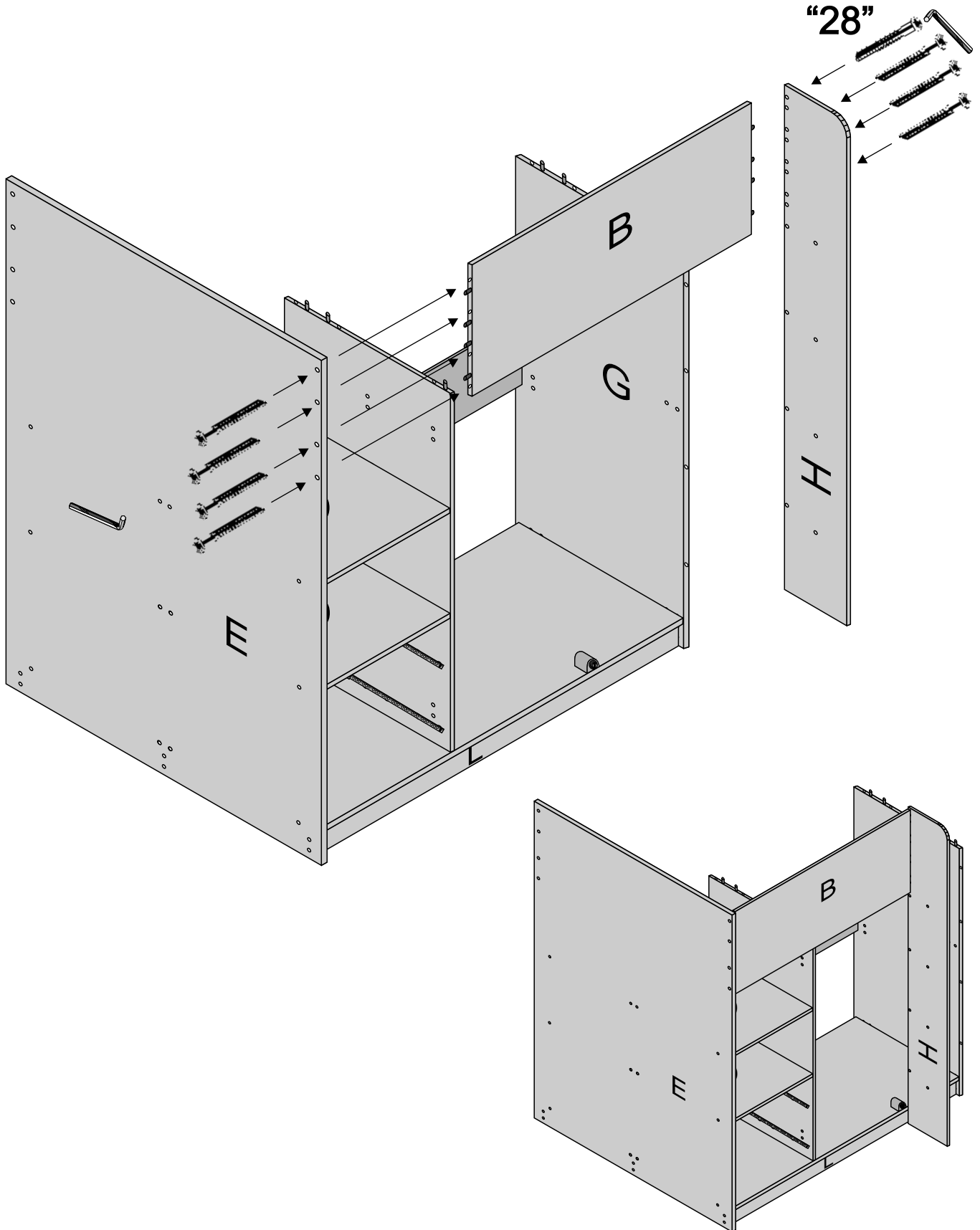
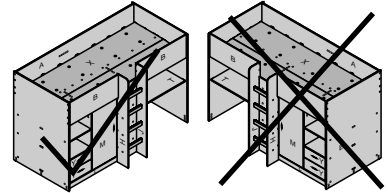
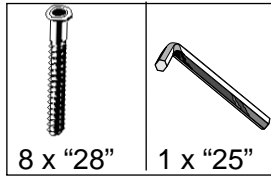

13

STEP 13 of 24 Exeter High Bed

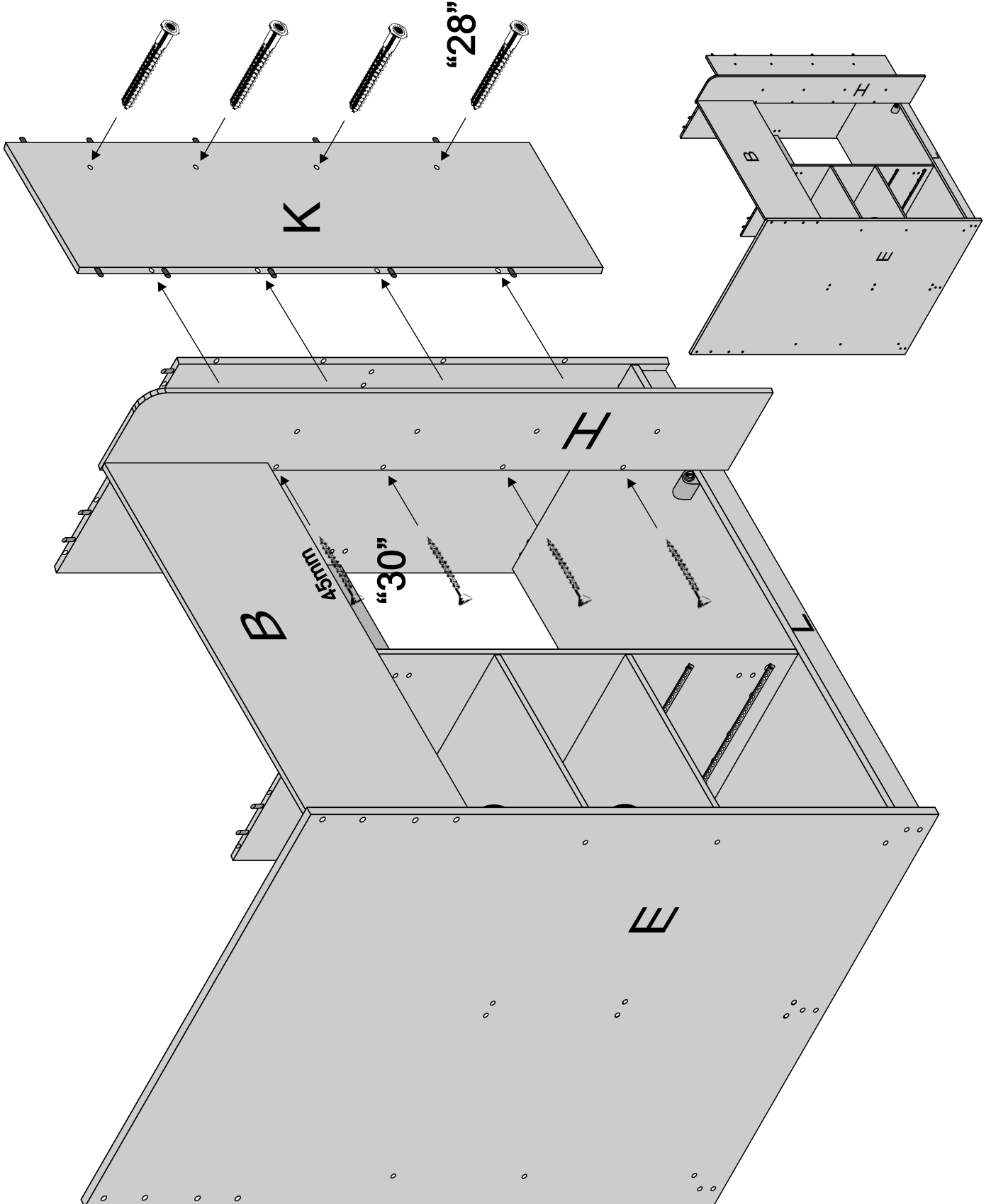
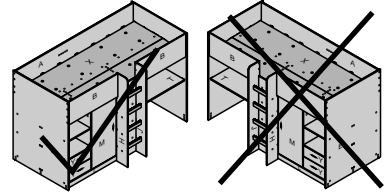
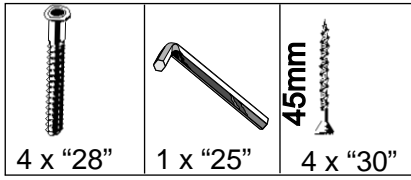



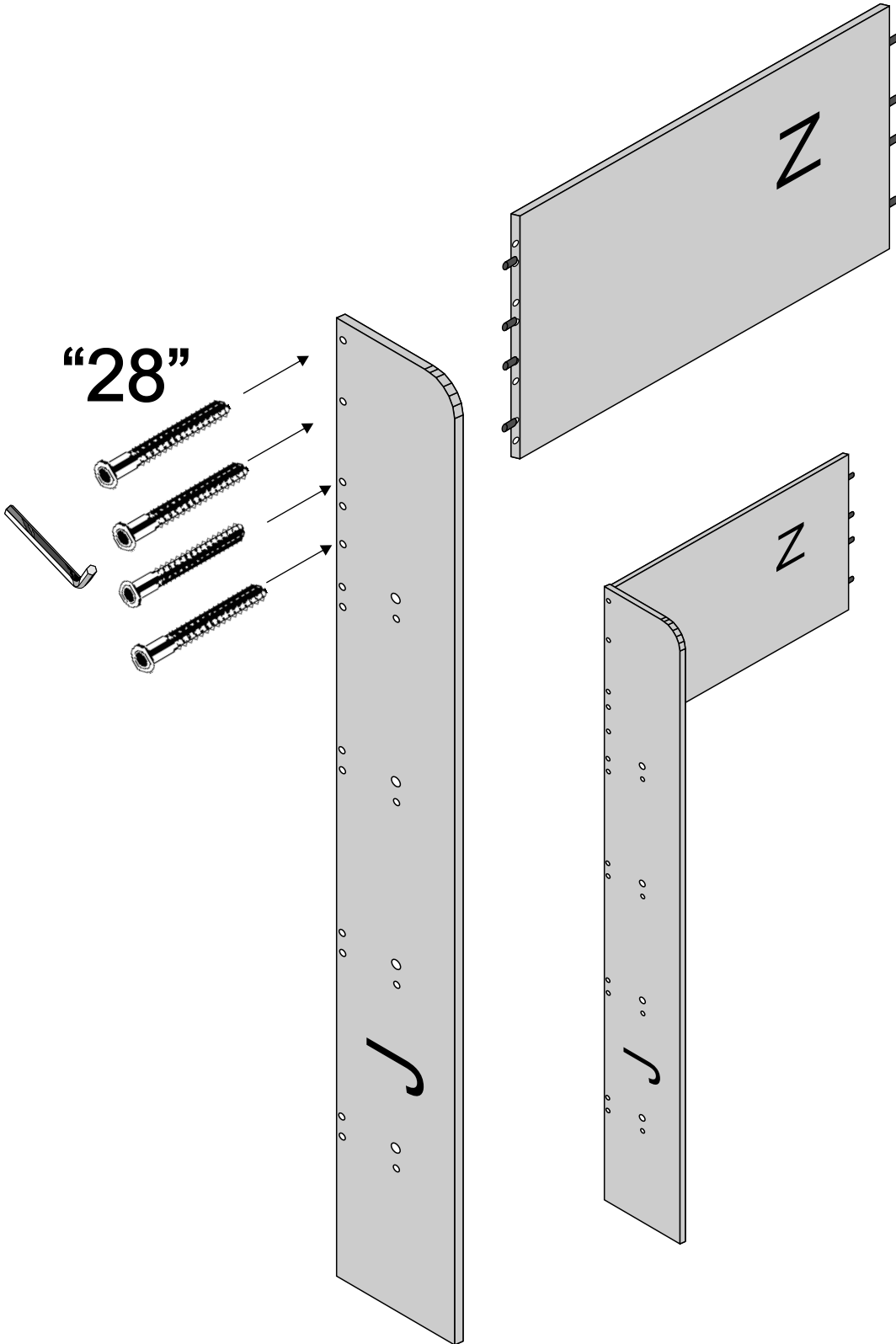
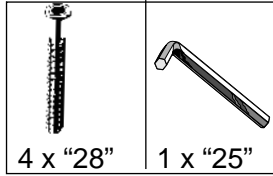
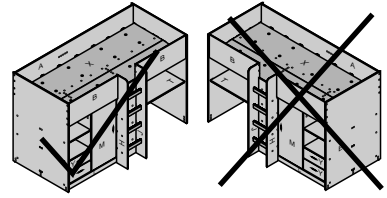

14

STEP 14 of 24 Exeter High Bed

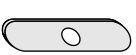

15

STEP 15 of 24 Exeter High Bed

 50mm x M6 8 x "18"	 1 x "25"	 1 x "151"	 45mm 4 x "30"
---	---	--	---

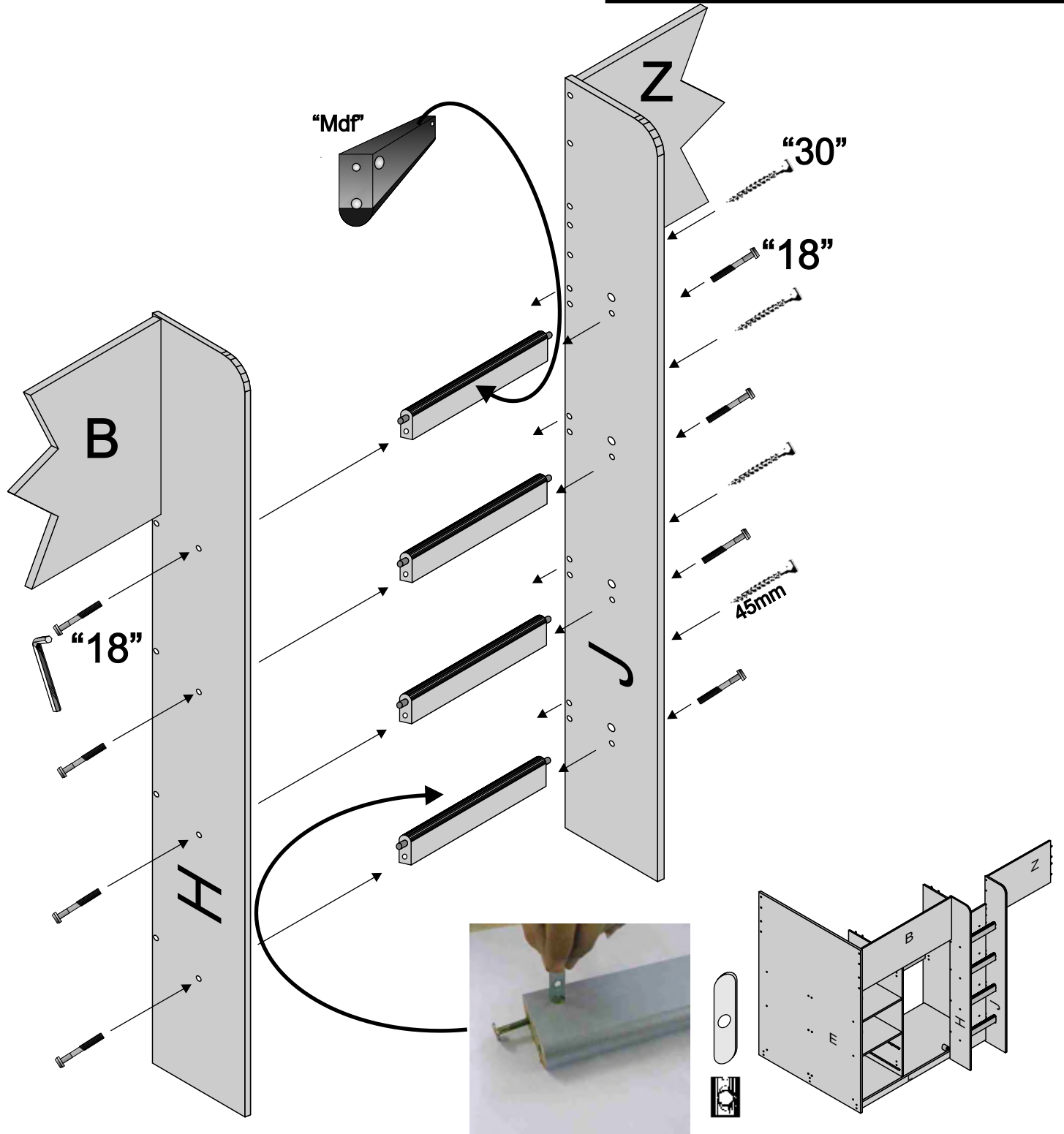
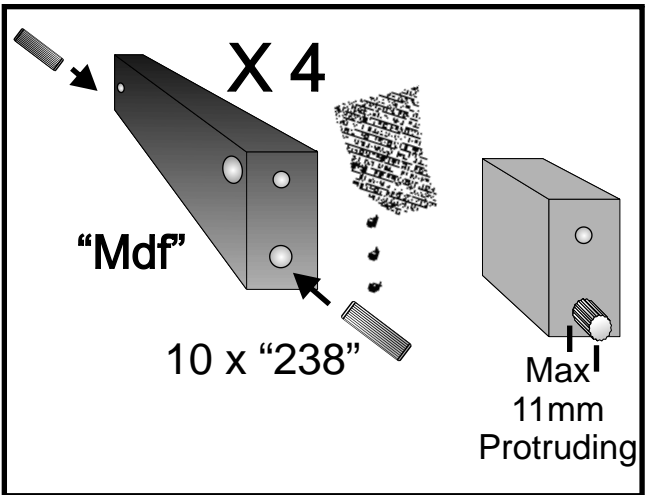
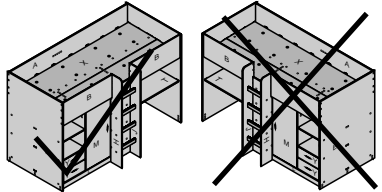

16

STEP 16 of 24 Exeter High Bed

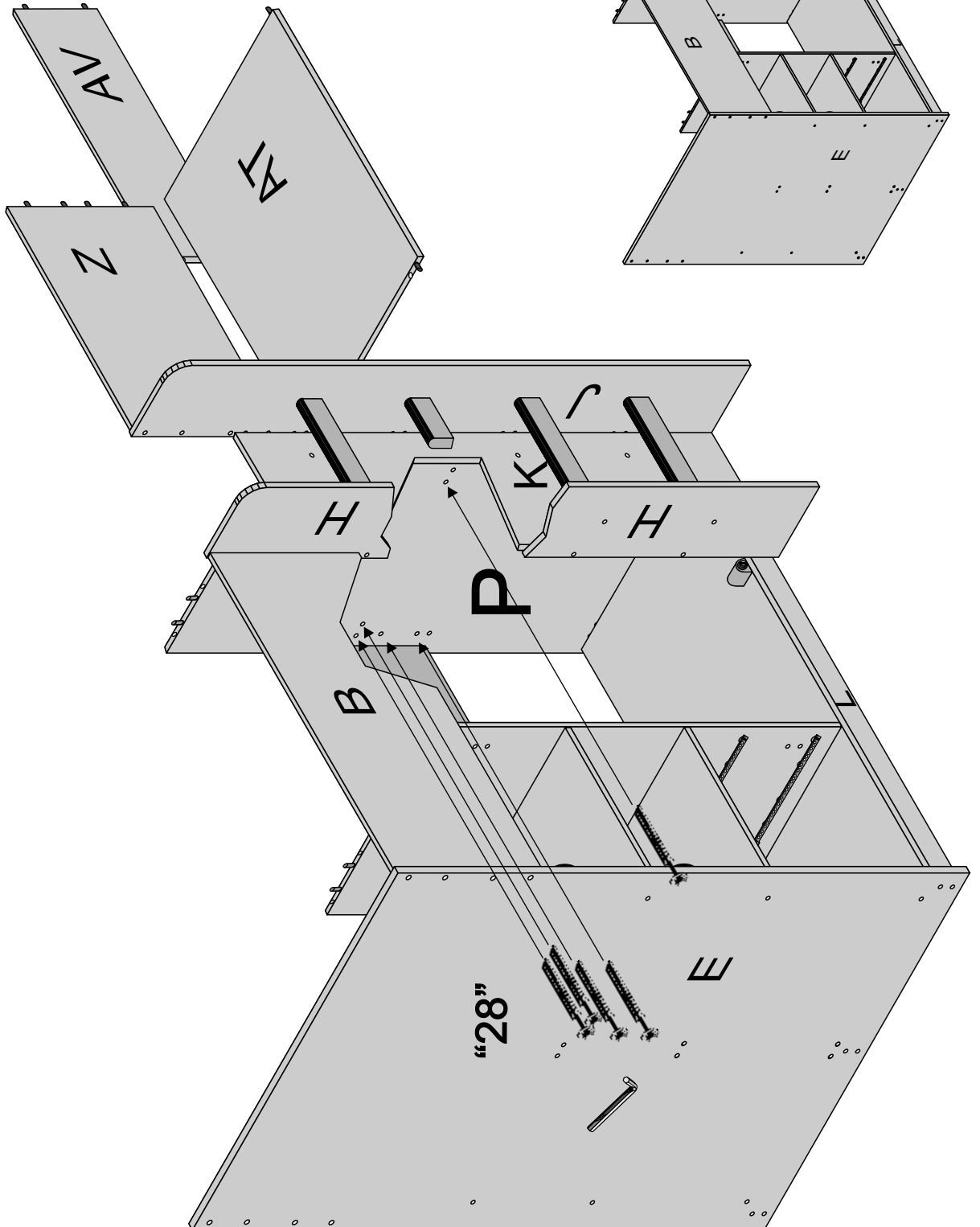
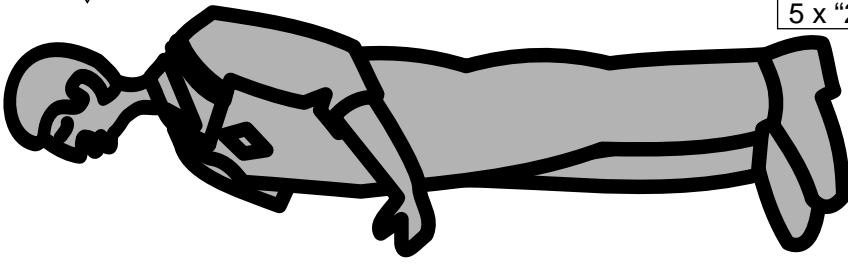
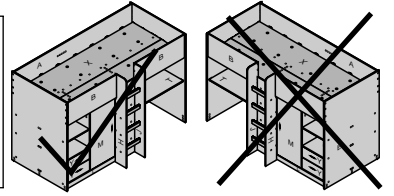
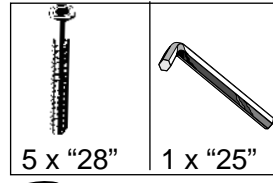

17

STEP 17 of 24 Exeter High Bed

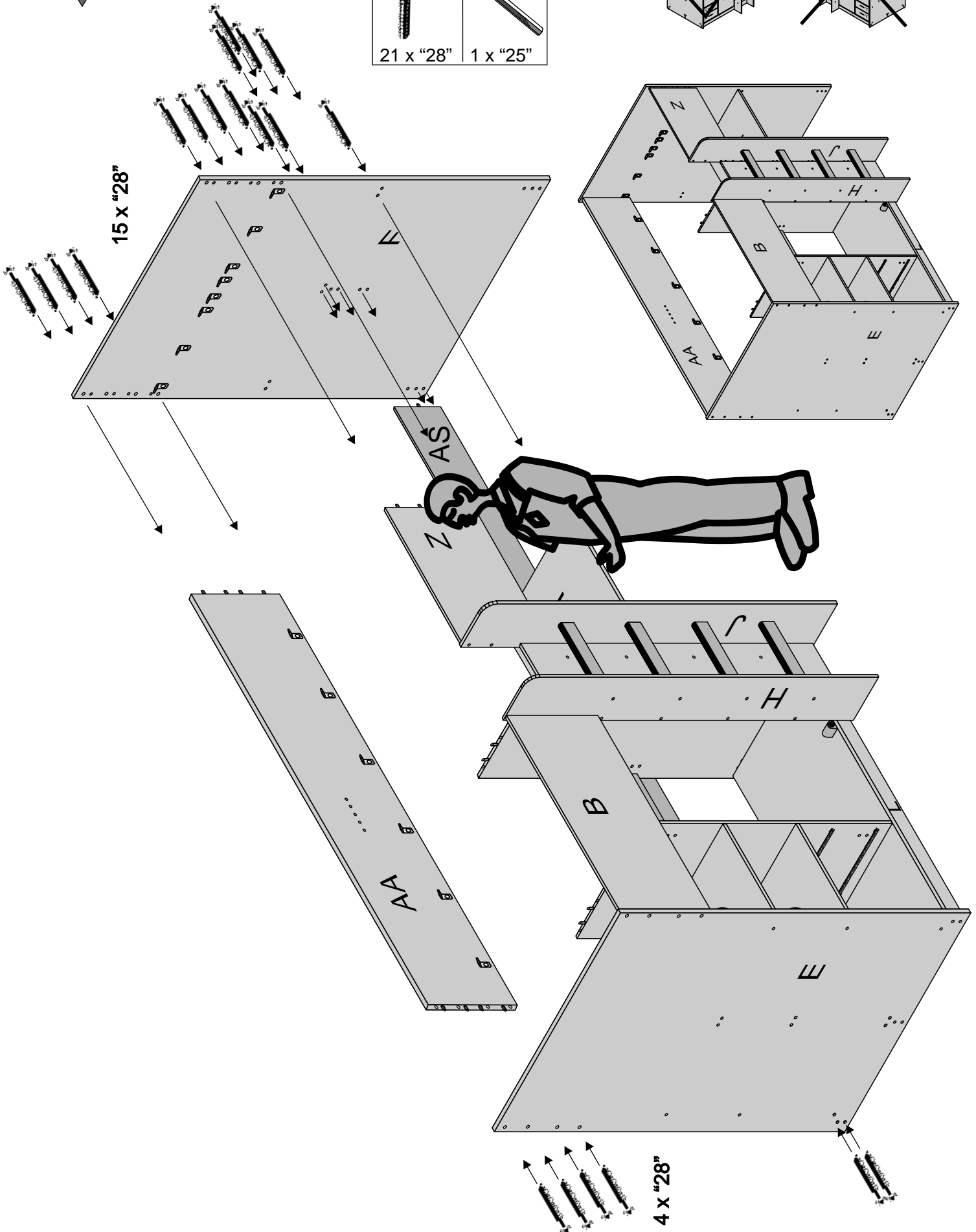
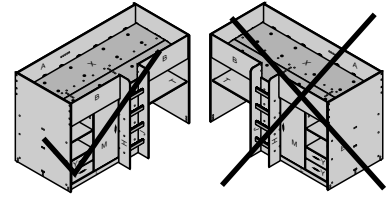
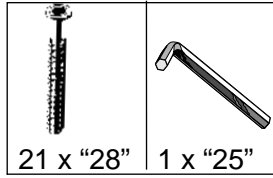

18

STEP 18 of 24 Exeter High Bed

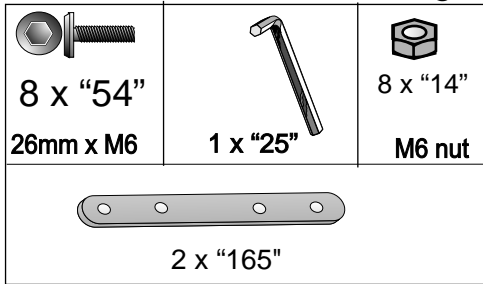

Place the bed bases into the bed.
Loosely attach the plates + "54",
do not fit the nuts "14".
Move the bed bases to the sides.
You will have a small gap in the middle.
Fit the nuts and tighten after step 19.

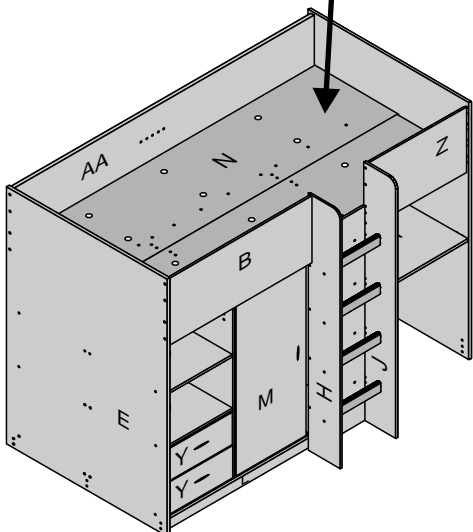
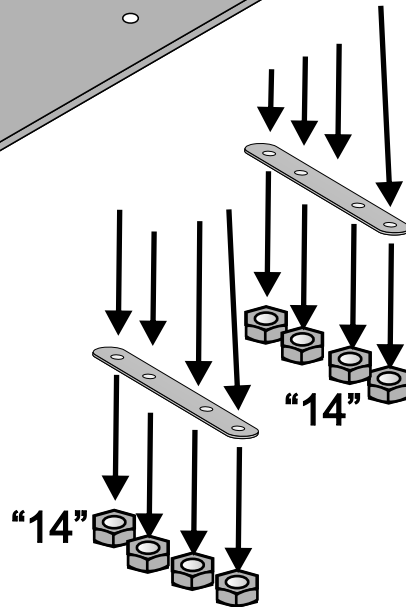
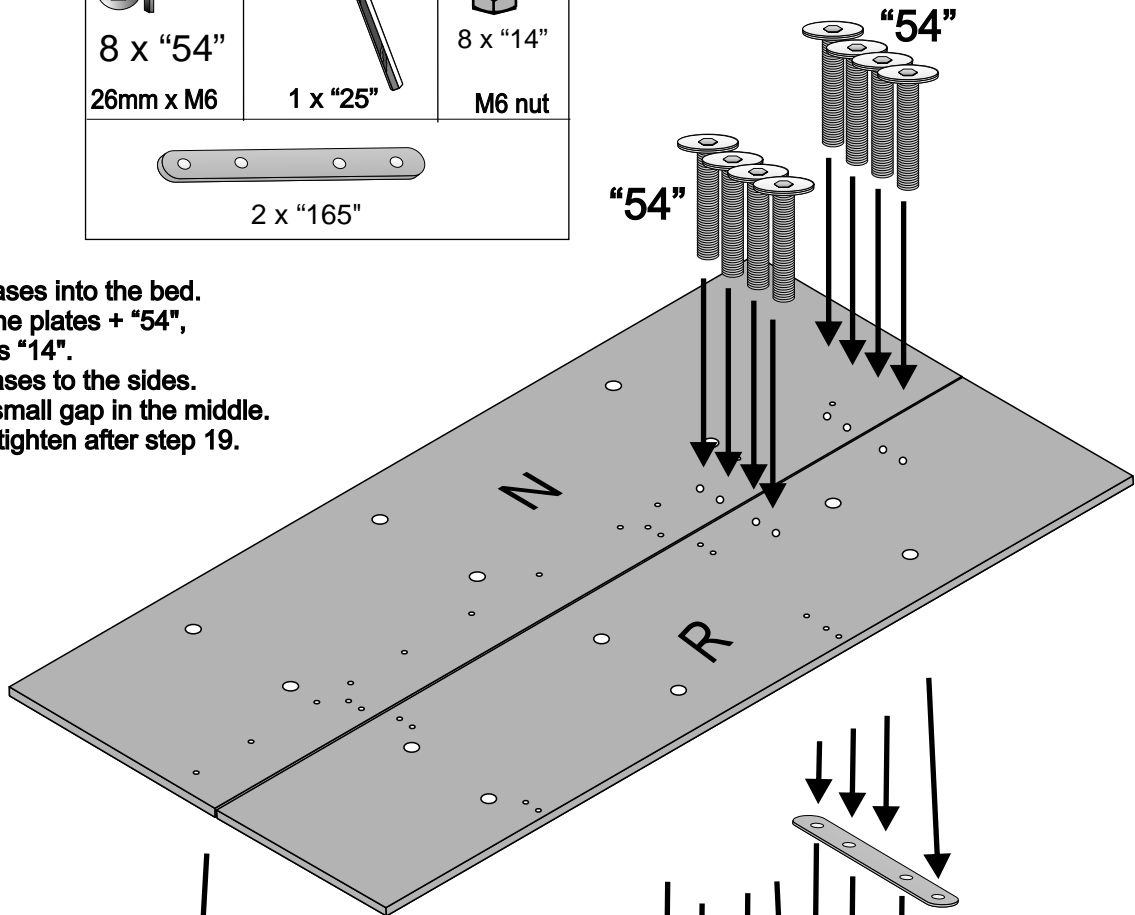

Plaats de bedbodems in het bed.
Losjes vast de platen + "54", passen niet de noten "14".
Verplaats de bedbodems aan de zijkanten.
U heeft een kleine opening in het midden.
Breng de bouten en moeren aan en draai na stap 19.

Placer les bases de lit dans le lit.
Fixez sans serrer les plaques + "54", ne cadrent pas avec les vis noix "14".
Déplacez les bases de lit sur les côtés.
Vous aurez un petit espace au milieu.
Monter les vis et les écrous et serrez après l'étape 19.



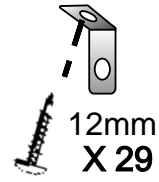
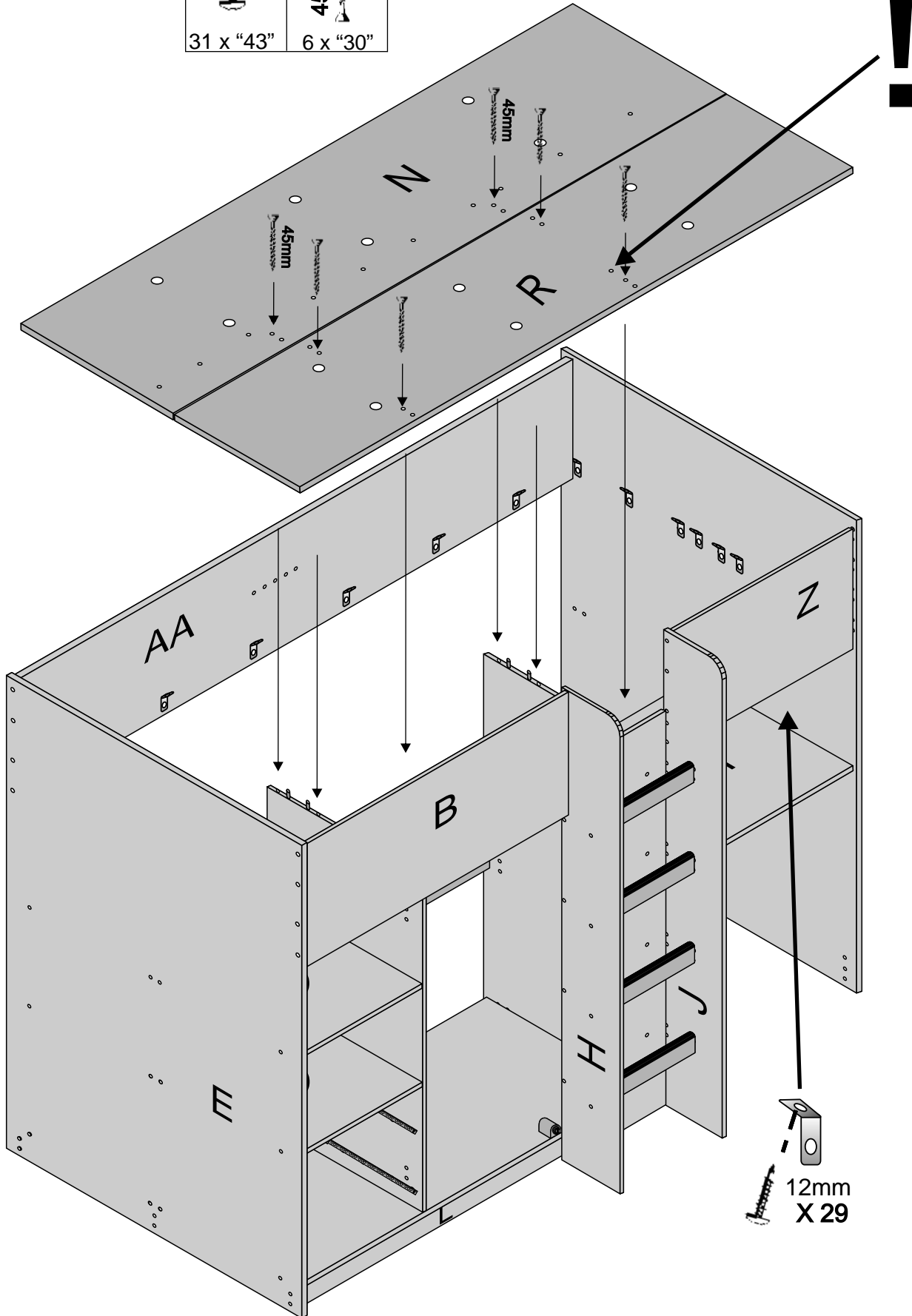
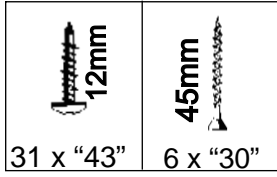
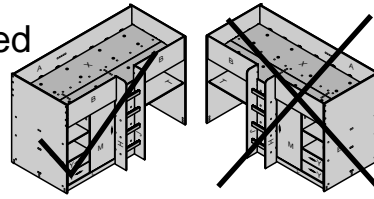

Legen Sie die Lattenroste ins Bett.
Locker an die Platten + "54", passen nicht die Muttern "14".
Verschieben Sie die Lattenroste an den Seiten.
Sie haben einen kleinen Spalt in der Mitte.
Die Schrauben und Muttern und ziehen Sie nach Schritt 19.

STEP 19 of 24 Exeter High Bed





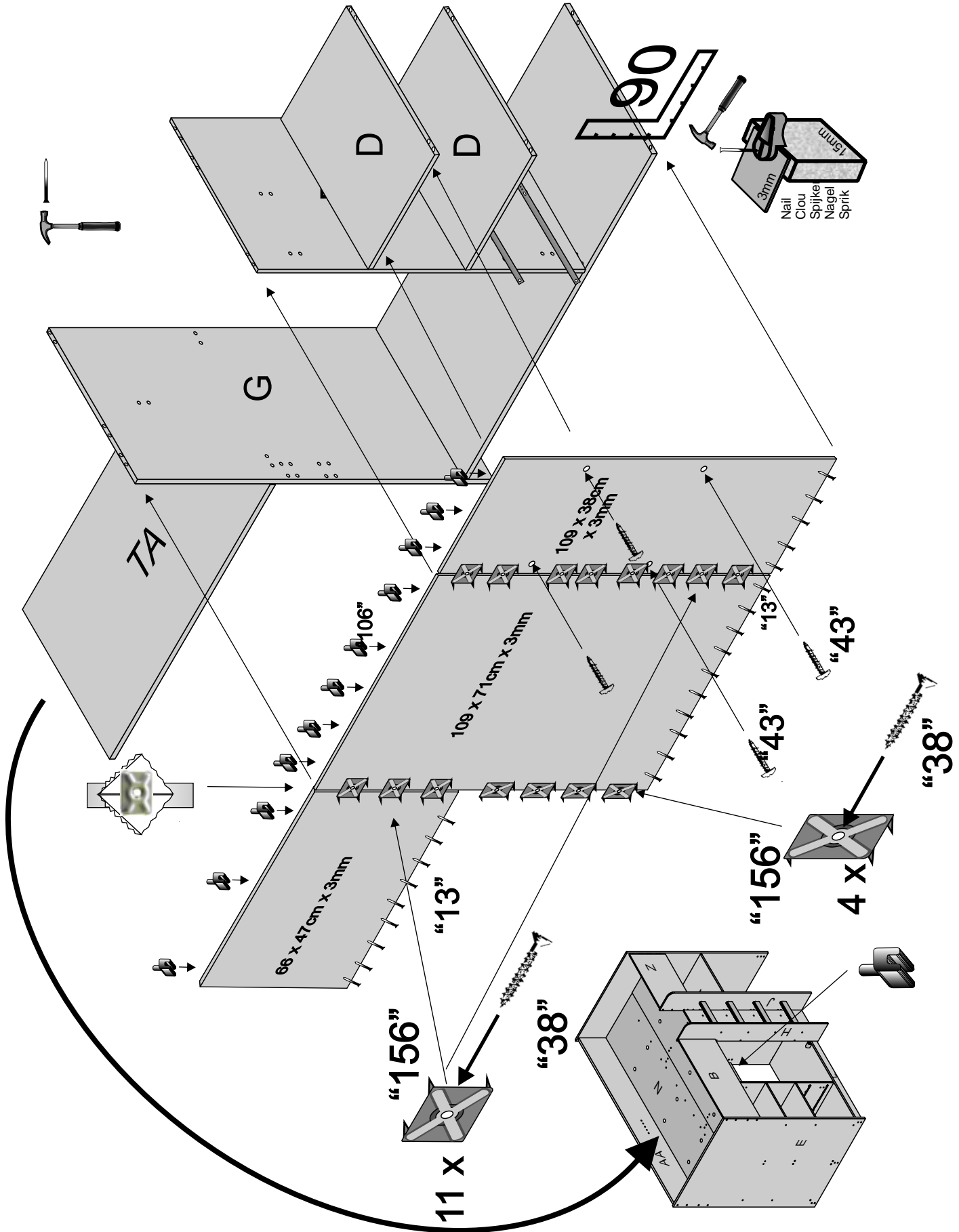
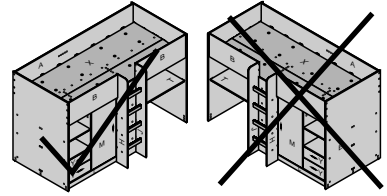
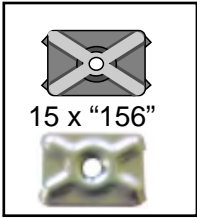

20

STEP 20 of 24 Exeter High Bed

			
27 x "13"	4 x "43"	11 x "106"	15 x "38"



		'131'		1
4 x "44"	2 x "205"			
		'19'		2

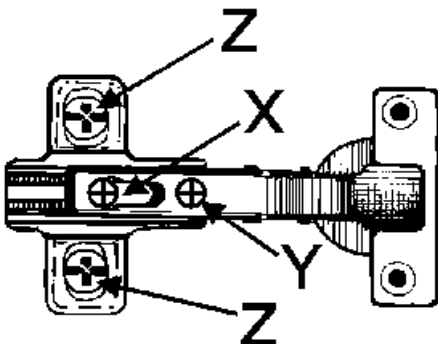
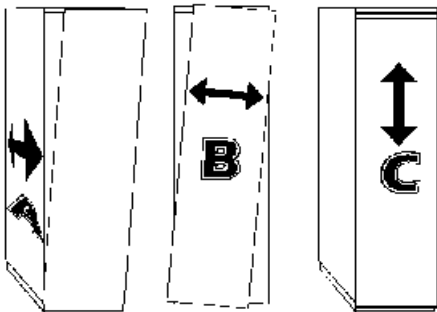
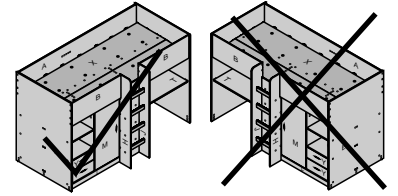
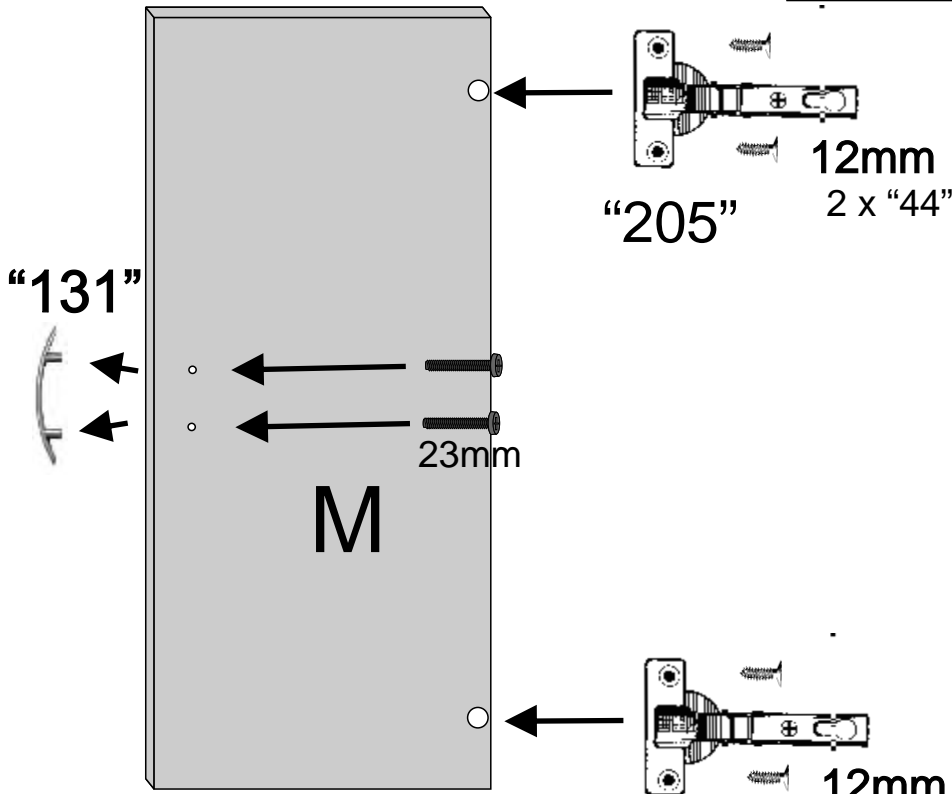

$$X = A$$

$$X + Y = B$$

$$Z = C$$

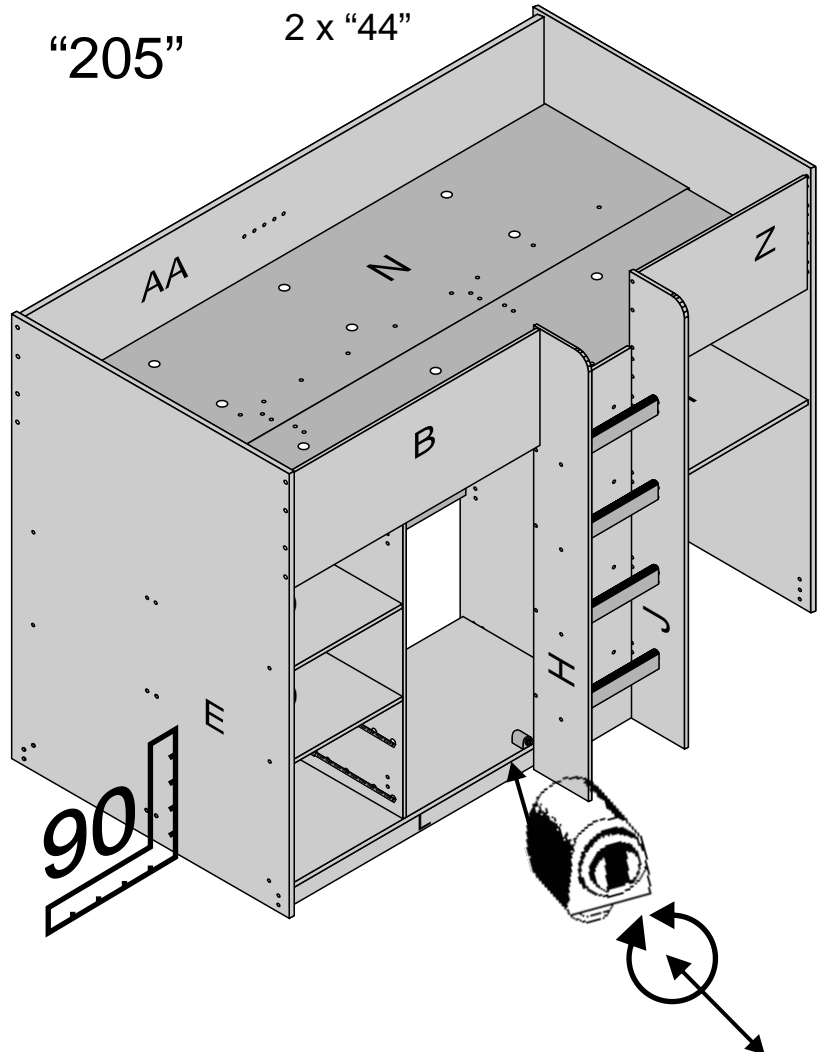
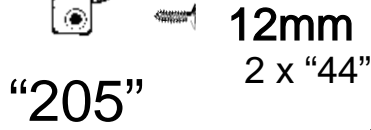

22

STEP 22 of 24 Exeter High Bed

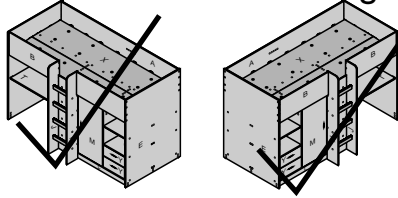

'131'		2
'19'		4
'219'		2

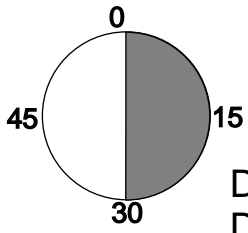

'131'



Dry
Droog
Trocknen
Secher
Kuru
Suchy

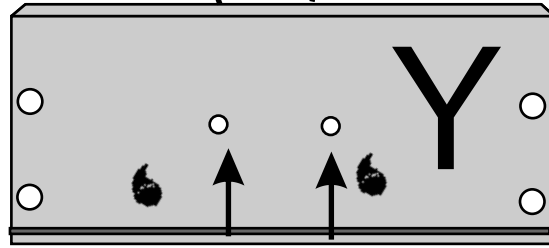

23mm X 2



35 x 34cm x 3mm

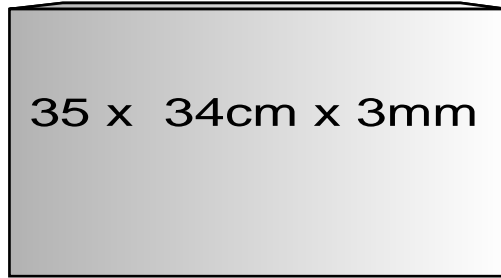

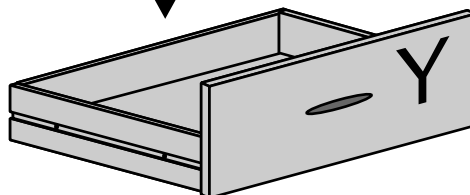

X 2

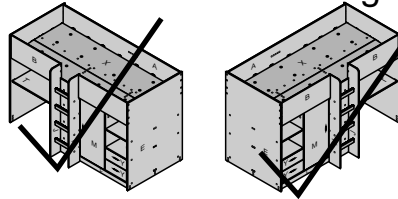

23

STEP 23 of 24 Exeter High Bed



'47'	 10mm	4
------	---	---

'47'

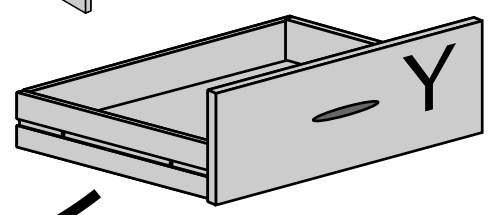
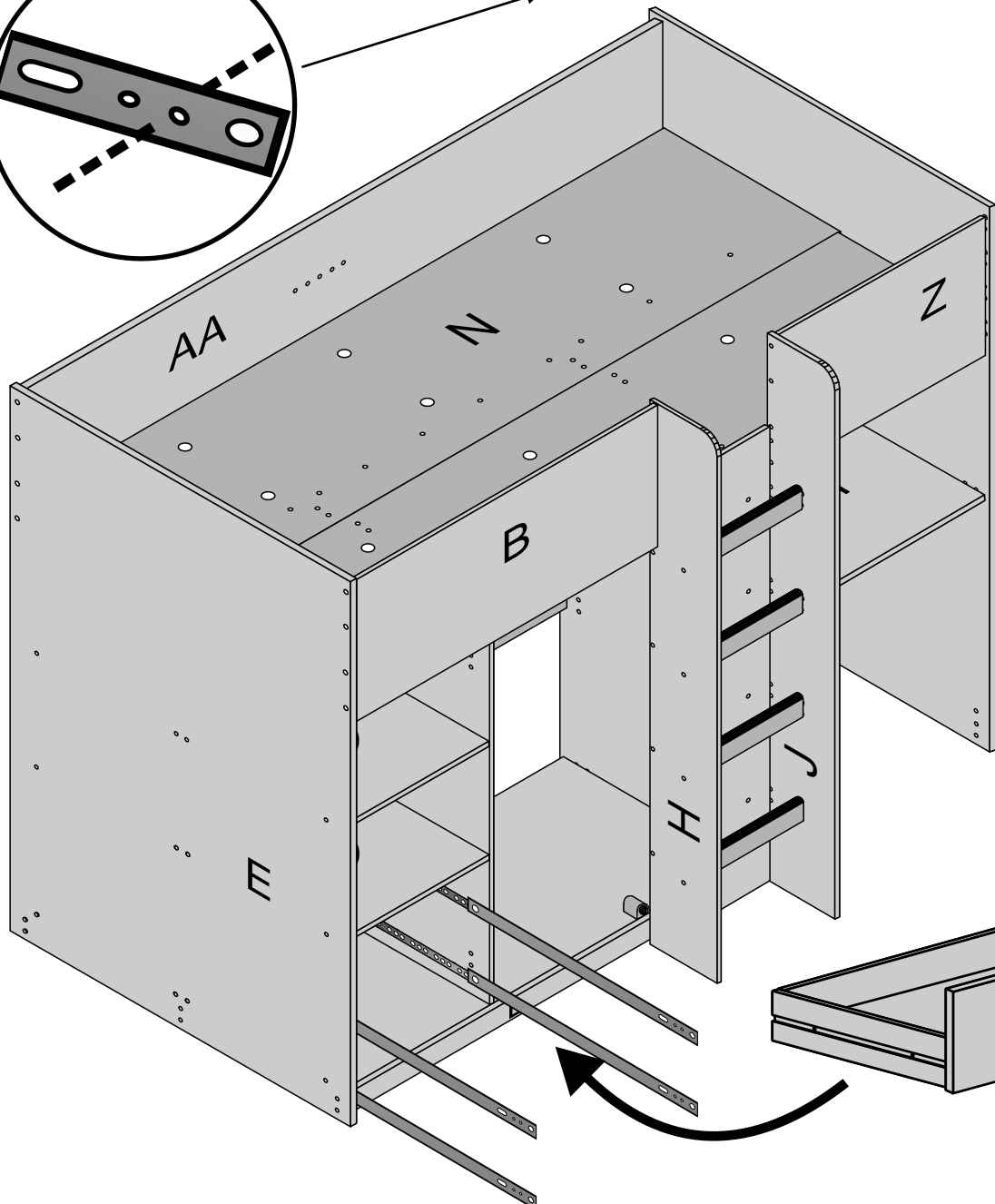
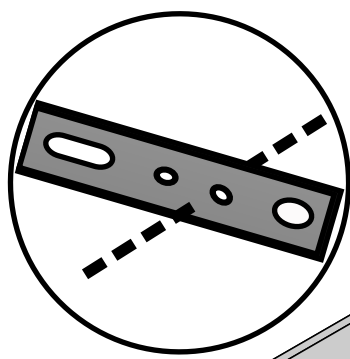
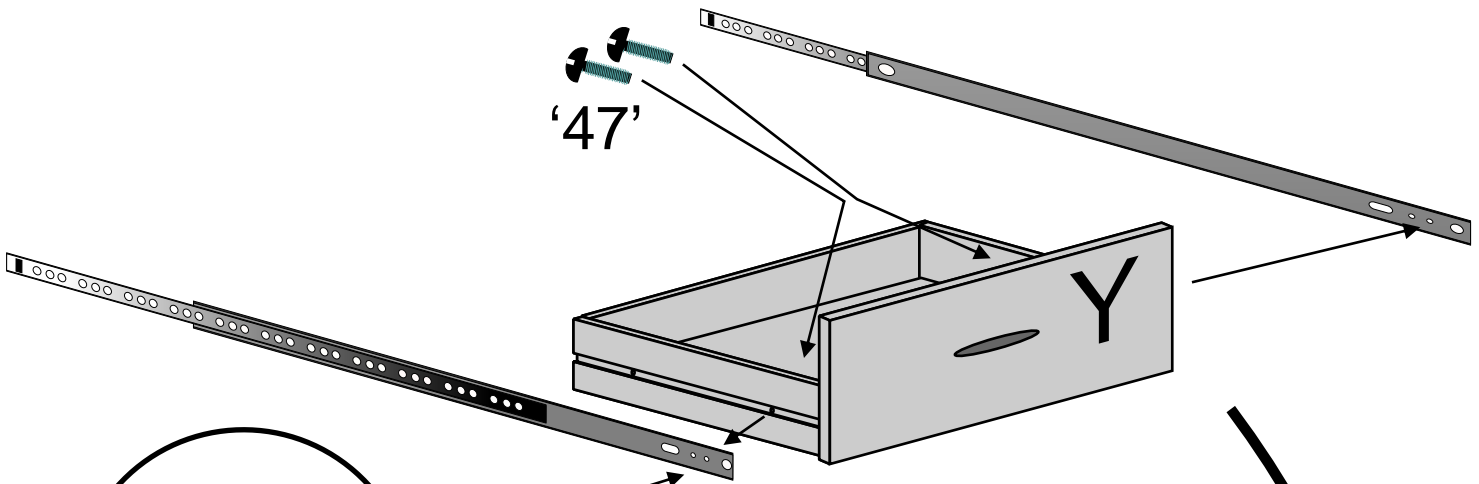

2 x

24

STEP 24 of 24 Exeter High Bed

'120'		69cm	1
-------	--	------	---

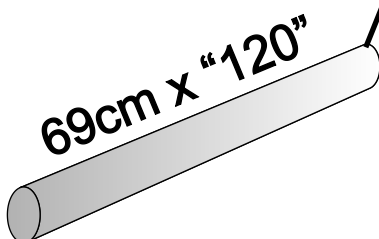
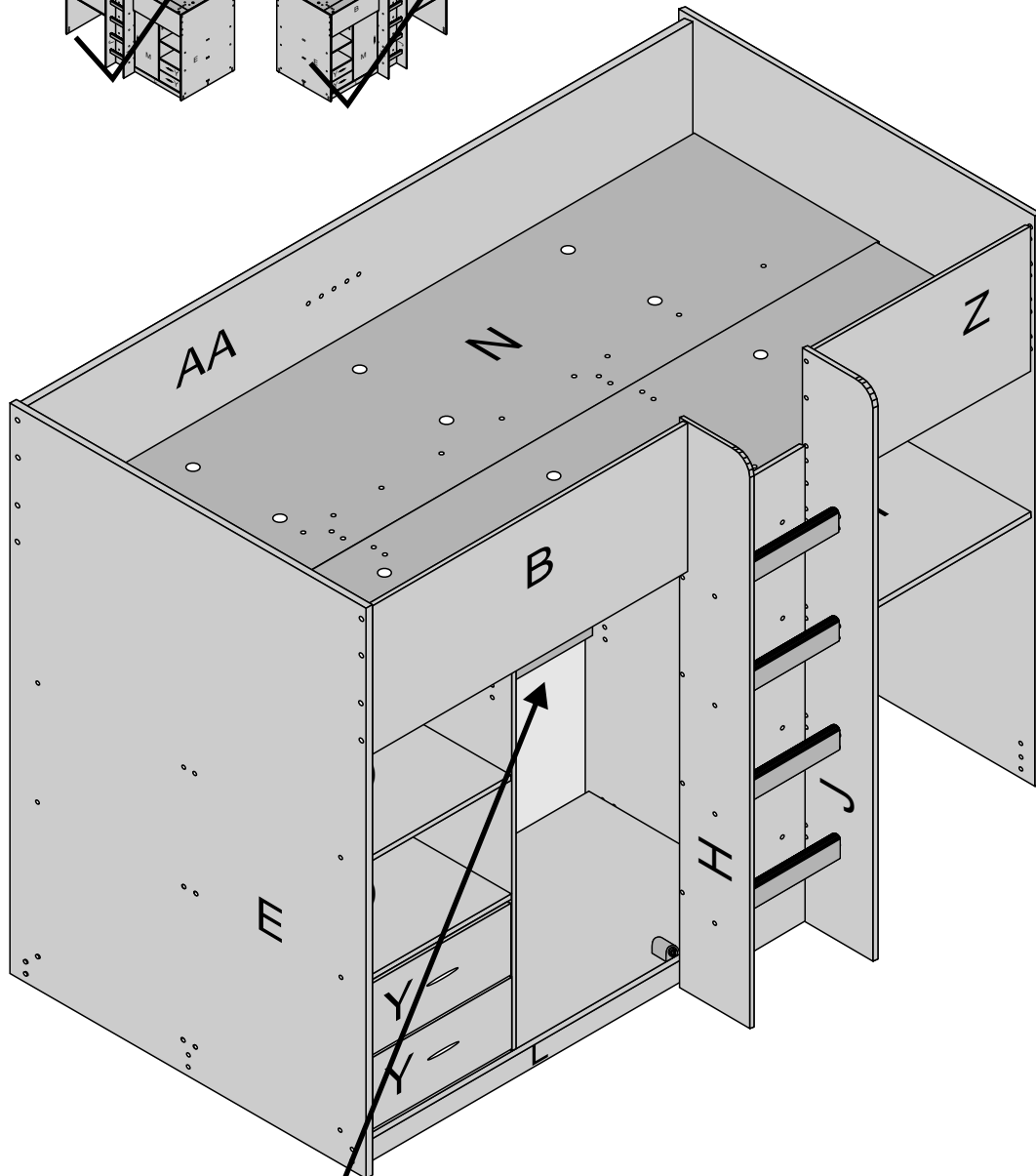
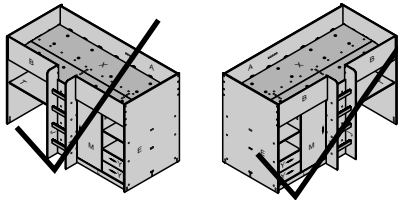
**WARNING! UK ONLY**

To ensure that the safety rail is high enough above the mattress, a line is marked on the inside of panel 'A' this is the highest point that the mattress should reach.

Be aware of the danger of young children (under 6) falling from the bed when assembled in its highest position.

Make sure you show your child how to safely climb the ladder.

DO NOT USE THE DESK TOP OR SHELF AS A LADDER.

UK Spares and Assembly HELPLINE 01572 755110
 Manufacturer - Belvoir Associates Ltd
 Pillings Road Oakham England