

Lifestyle Bed

0
10
20
30
40
50
60
70mm

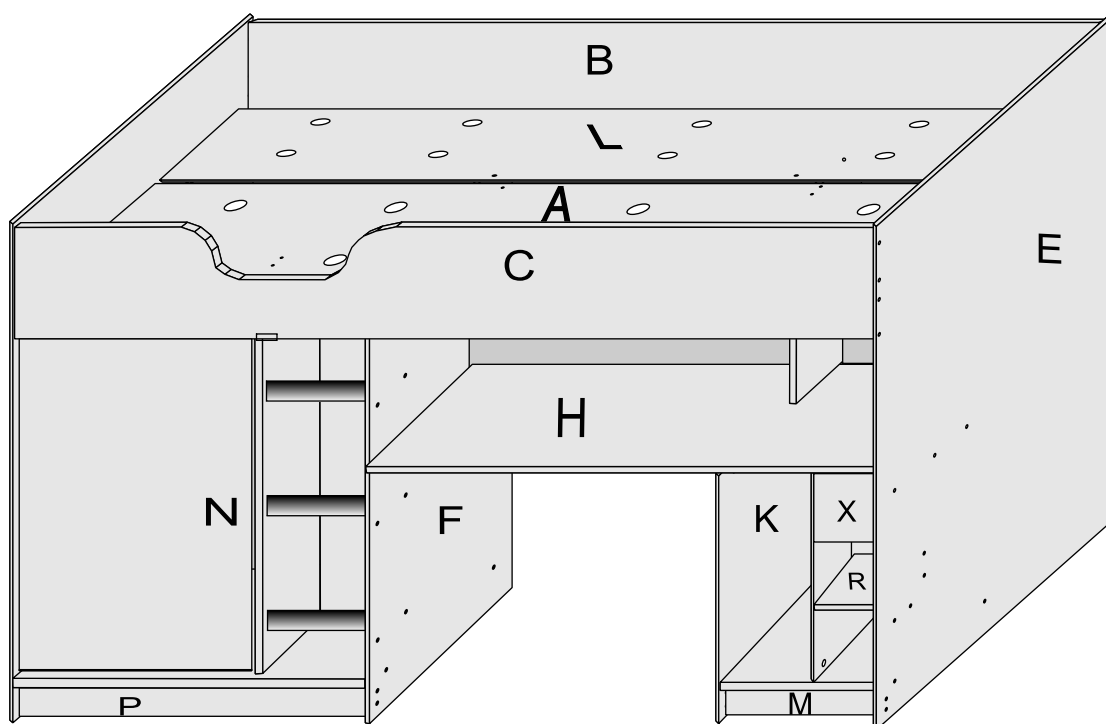

D	Montageanleitung Bett Lifestyle	GB	Assembly instructions Bed Lifestyle	FR	Notice de montage Lit Lifestyle
NL	Montage-instructies Bed Lifestyle	PL	Instrukcje montazu Łózko Lifestyle	SK	Návod na montáž Postel Lifestyle
TR	Montaj talimatları Yatak Lifestyle	RU	Инструкция по монтажу Bed Lifestyle	HU	Szerelési útmutató Agy Lifestyle
IT	Istruzioni di montaggio Letto Lifestyle	CZ	Montážní návod Postel Lifestyle	RO	Instrucțiuni de montaj Pat Lifestyle

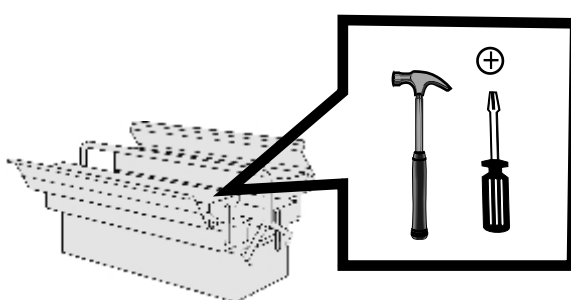
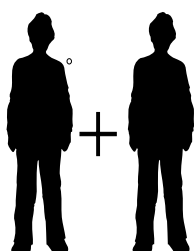
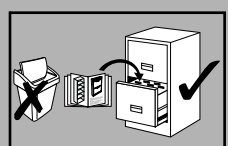







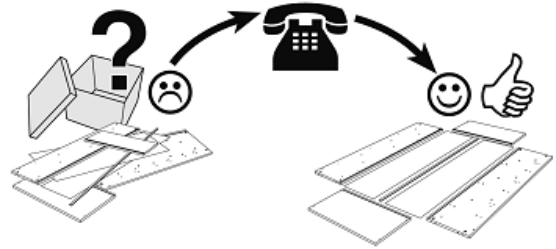





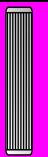



Lifestyle Bed

Service • Assistenza • Dienstverlening • Serwis
 Servis • Szerviz • Сервисная служба

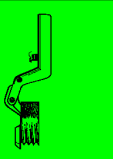
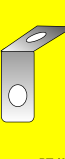
Name • Nom • Nome • Naam • Nazwa • Jméno • Název • Név • Denumire • Ísim • Название	Lifestyle
Nr. • No. • N° • Номер • Č • Sz	
Typ • Type • Tip • Típus • Тиро • Тип	
	

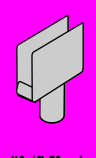

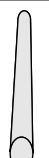
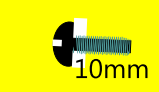
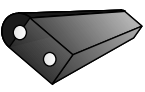
 68 X "30" 45mm screws	 14 X "44" 12 x No6,BZP,Pozl,CSK	 52 X "43" 12x6 Pan BZP Pozl	 1 X "45" 11 x No4, Brs, Pozl	 1 X "17"
 6 X "238" 3mm dowel	 31 X "220" 38 x 3mm dowel	 54 X "13" Pin	 6 X "191" Large Nail	 4 X "19" 4 x 23mm Pin
 6 X "181" Shell Camo-Tilus	 6 X "182" Shell Pine-Tilus	 6 X "23" 18mm Barrel Nut	 6 X "18" 51 x 6mm Bolt	1 x "219"  =  Glue
 1 X "25" 4mm Allen key	 2 X "205" 17mm Crank Hinge	 2 X "206" Hinge Plate	 26 X "155" DT 484	 2 X "118" Hang supp
 4 X "106" U Capl Shelf Support	 2 X "131" 6mm Metal Dowel	 62 X "67" Pozl Cover Cap	 1 X "125" 79cm Oval Rail	 1 X "122" 32mm Stop
 1 x "534" U Channel 2.2 meter	 1 X "63" 747mm Runner Pairs	 2 X "47" 10mm x 4mm	 3 X "569" "Mdf" MDF Foot Rail	

Belvoir Associates Ltd
 51 Pillings Road
 Oakham
 Rutland
 England
 LE15 6QF

EN 747-1:2012+A1:2015

Made in the UK

**WICHTIG - BITTE SORGFÄLTIG LESEN -
BEHALTEN FÜR ZUKÜNFTIGE VERWEIS
IMPORTANT - READ CAREFULLY - RETAIN FOR
FUTURE REFERENCE**

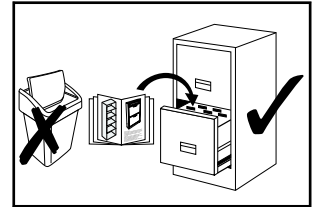

- 1. WARNING;** High Beds and the upper beds of bunk beds are not suitable for children under six years of age due to the risk of injury from falls.
- 2. WARNING;** Bunk beds and High beds can present a serious risk of injury from strangulation if not used correctly. Never attach or hang items to any part of the bunk bed or high bed that are not designed to be used with the bed, for example, but not limited to ropes, strings, cords, hooks, belts and bags.
- 3. WARNING;** Children can become trapped between the bed and the wall, a roof pitch, the ceiling, adjoining pieces of furniture (e.g. Cupboards) and the like. To avoid risk of serious injury the distance between the top safety barrier and the adjoining structure shall not exceed 75 mm or shall be more than 230 mm.
- 4. WARNING;** Do not use the bunk bed or high bed if any structural part is broken or missing.
- Always follow the manufacturers instructions to assemble the bed.
- The recommended size of mattress for this bed is 200 x 90 x 10cm.
- The maximum mattress thickness is 10cm. The maximum height is marked on the back of the front panel of the bed.
- Ventilation of the room is necessary in order to keep the humidity low and to prevent mould in and around the bed.
- All assembly fastenings, including screws, should be regularly checked to ensure they are properly tightened.
- The bed is made to EN 747-1:2012+A1:2015 (E).

**WICHTIG - BITTE SORGFÄLTIG LESEN -
BEHALTEN FÜR ZUKÜNFTIGE VERWEIS
IMPORTANT - READ CAREFULLY - RETAIN FOR
FUTURE REFERENCE**

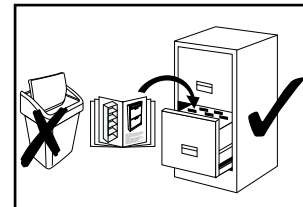

NL

- 1. Waarschuwing: Hoogslapers en stapelbedden zijn niet geschikt voor kinderen jonger dan 6 jaar i.v.m. het risico van vallen.**
- 2. Waarschuwing: Als het bed niet correct gebruikt wordt is er een verhoogd risico van letsel door verklemming of wurging. Verbind er daarom geen artikelen die geen deel uit maken van het bed zoals ondermeer ; touwen, riemen, koorden, haken en zakken aan .**
- 3. Waarschuwing; Om te voorkomen dat kinderen tussen het bed en andere meubels of plafond of muur klem komen te zitten moeten de volgende afstanden tussen de veiligheidsbarriere en de aangrenzende structuur aangehouden worden. De afstand mag niet meer dan 75 mm maar moet meer dan 230mm zijn.**
- 4. Waarschuwing; Gebruik het stapelbed of de hoogslaper niet als een structureel onderdeel ontbreekt of gebroken is.**
- 5. Bouw het meubel volgens de instructies van de fabricant.**
- 6. Aanbevolen matrasmaat 200x90x10cm .**
- 7. Maximum matras dikte 10cm. De maximale hoogte is duidelijk op de achterkant**
- 8. van het voorpaneel van het bed.**
- 9. Ventileer de kamer om schimmel en vocht vorming te voorkomen .**
- 10. Alle montage bevestigingen zoals schroeven moeten regelmatig worden gecontroleerd om ervoor te zorgen dat ze goed zijn vastgedraaid.**
- 11. Het bed voldoet aan EN 747-1:2012+A1:2015**

F

- 1. MISE EN GARDE; Les lits mezzanine et les lits du haut dans les lits superposés ne conviennent pas à des enfants de moins de 6 ans en raison des risques du chute.**
- 2. MISE EN GARDE; Si on ne respecte pas les consignes d'utilisation, on peut s'exposer à un sérieux risque de strangulation.**
Il ne faut jamais attacher ou pendre à aucune partie du lit superposé ou du lit mezzanine un élément qui ne soit pas conçu pour être utilisé avec lit, comme, par exemple, des cordes, des ficelles, des cordons, des crochets, des ceintures et des sacs, la liste n'étant pas exhaustive.
- 3. MISE EN GARDE; Les enfants peuvent se retrouver coincés entre le lit d'une part et d'autre part le mur, la pente du toit, le plafond, les meubles attenants et autre éléments semblables. Pour éviter tout risque de blessure grave, la distance entre la barrière de sécurité du haut et la structure attenante devra faire moins de 75mm ou plus de 230mm.**
- 4. MISE EN GARDE; Ne pas utiliser le lit superposé ou le lit mezzanine si un élément de la structure est cassé ou manquant.**
- 5. Toujours suivre les instructions du fabricant pour assembler le lit.**
- 6. Pour ce lit il est recommandé d'utiliser un matelas 1 personne (200 x 90 x 10cm).**
- 7. L'épaisseur du matelas ne doit pas dépasser 10cm. La hauteur maximale est marqué sur l'arrière de le dos panneau avant du lit.**
- 8. Il est nécessaire de bien ventiler la chambre pour réduire au maximum le taux d'humidité et empêcher tout risque de moisissure a l'intérieur et autour du lit.**
- 9. Tous les éléments permettant la bonne tenue de l'assemblage, y compris les vis, doivent être régulièrement inspectés pour s'assurer qu'ils sont correctement vissés.**
- 10. Le lit respecte les normes Europeennes EN 747-1:2012+A1:2015**

Lifestyle High Bed

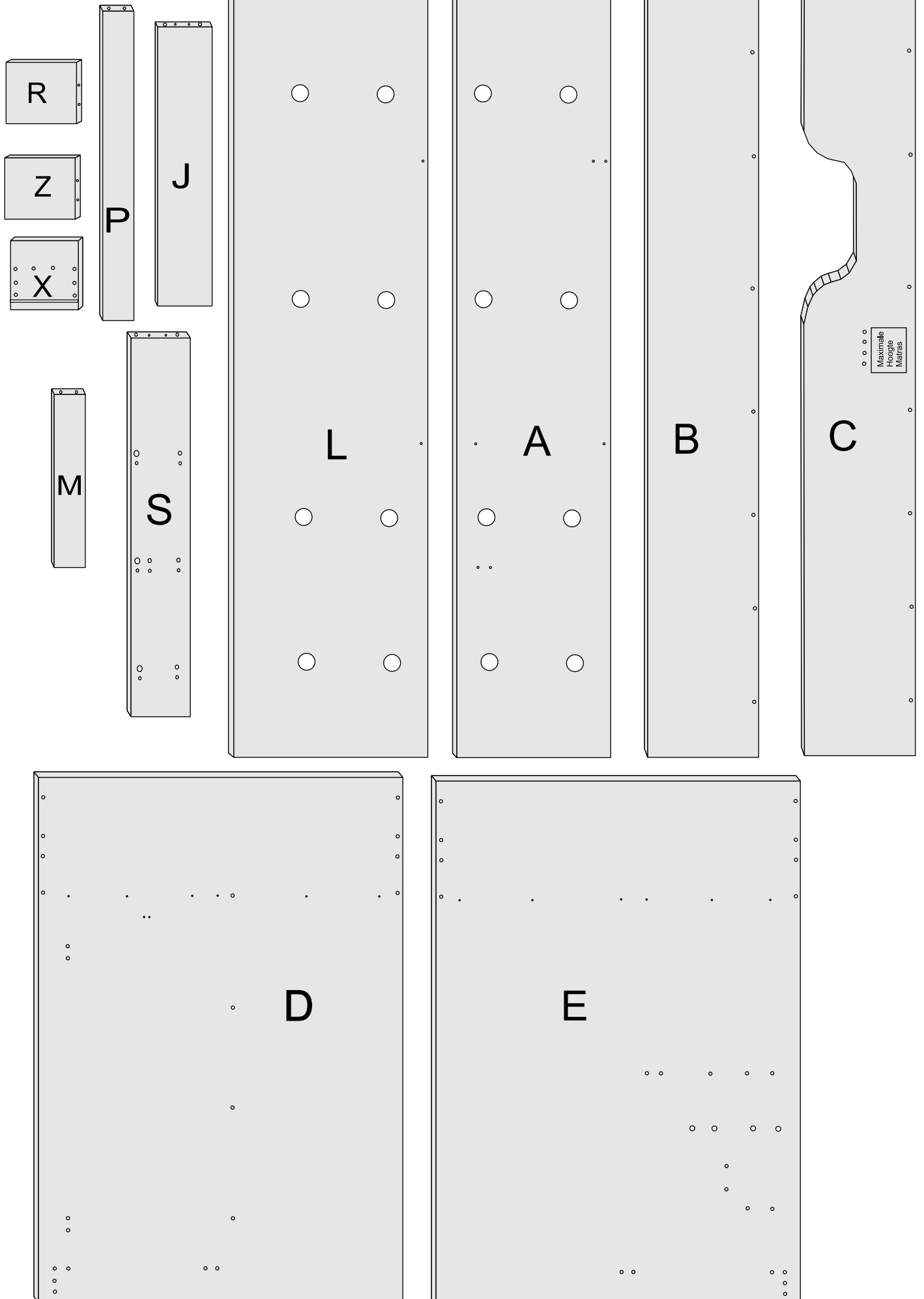

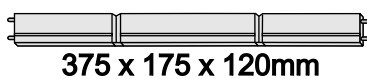
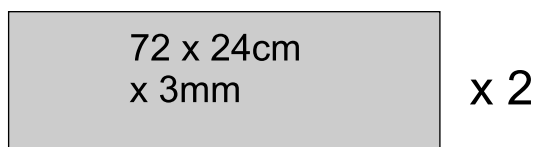
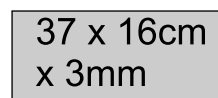
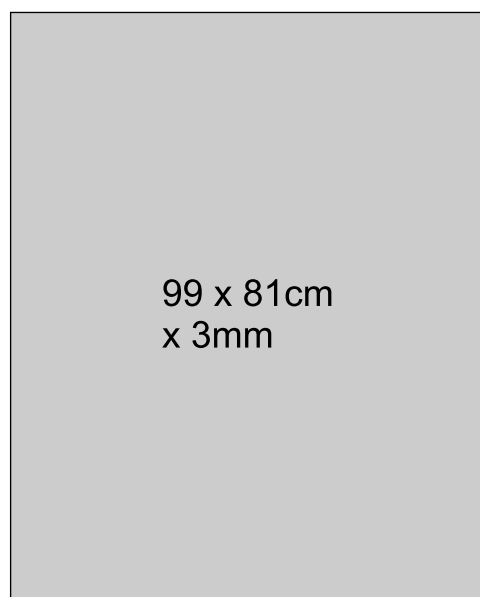
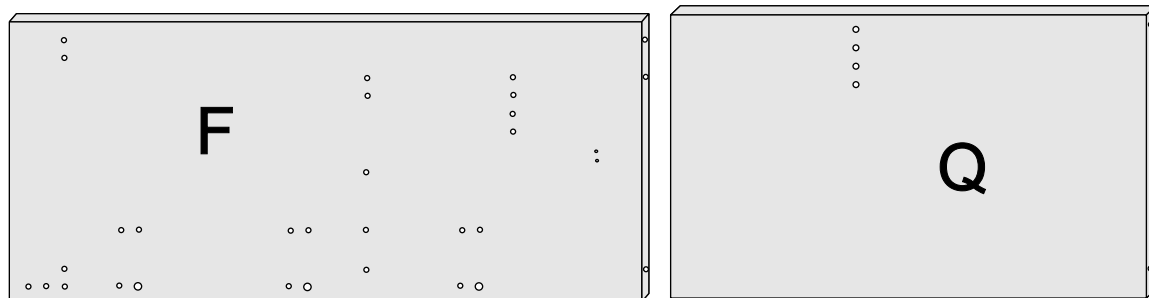
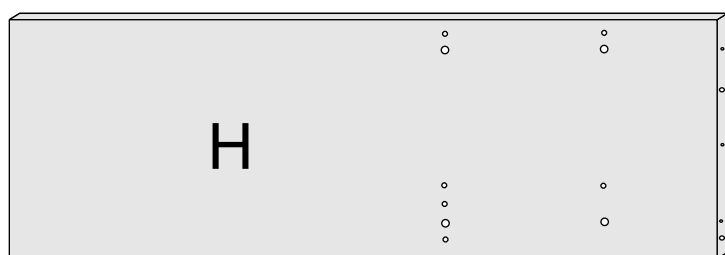
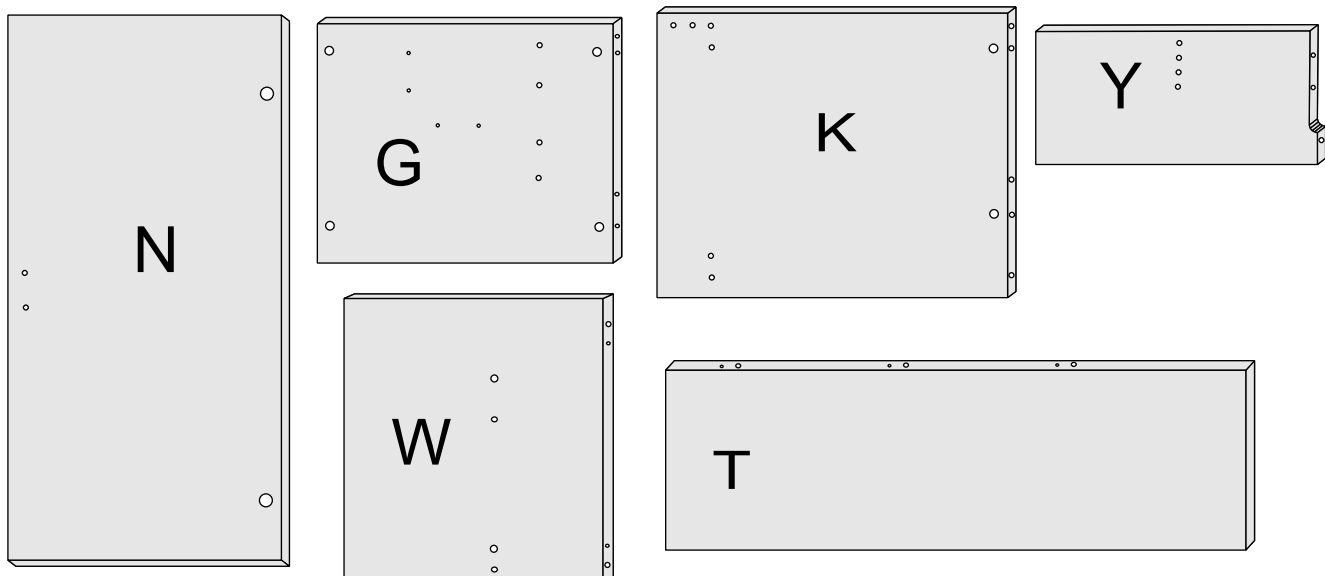

Lifestyle High Bed



1

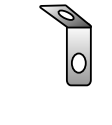

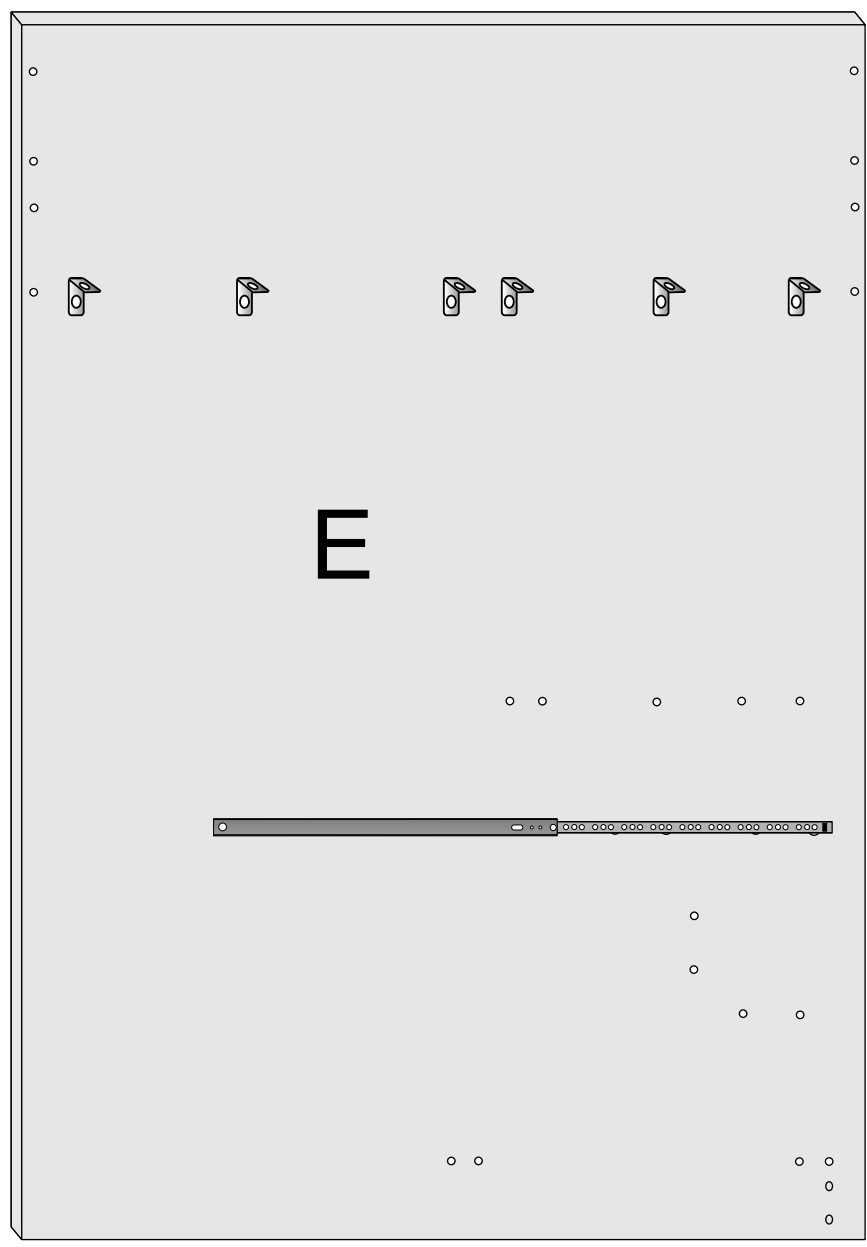
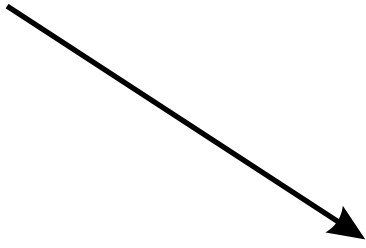
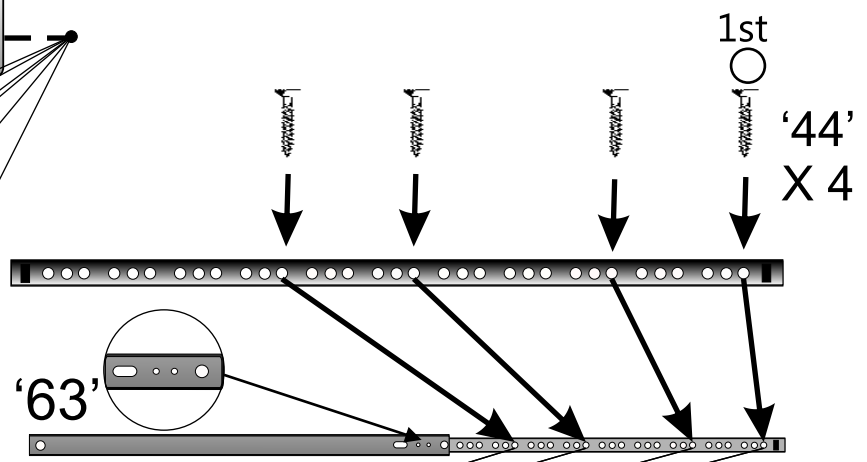
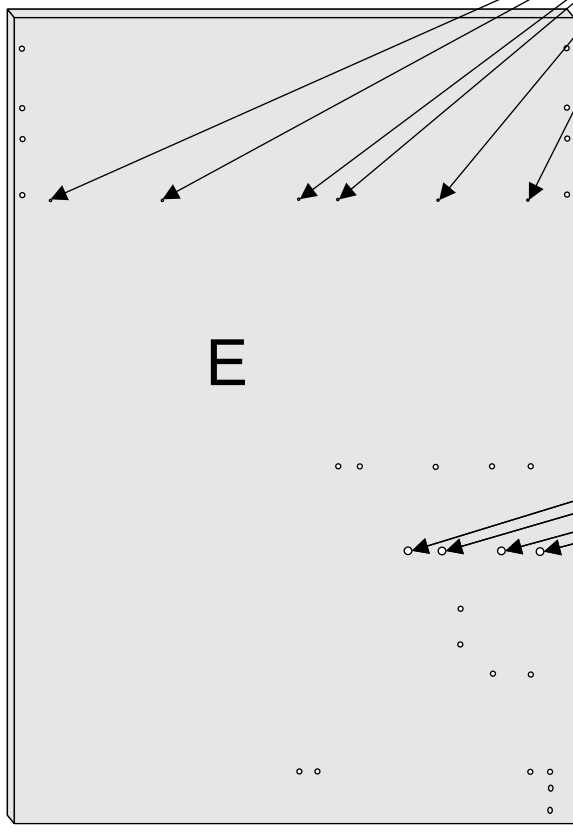
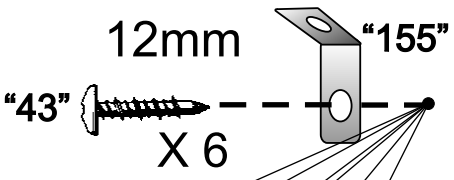

STEP 1 of 19 Lifestyle High Bed

 12mm 6 x "43"	 6 x "155"	 1 x "63"	 12mm 4 x "44"
--	--	--	--



2

STEP 2 of 19 Lifestyle High Bed

 12mm 6 x "43"	 6 x "155"	 2 x "206"	 12mm 1 x "44"	 1 x "118"
---	---	---	--	---

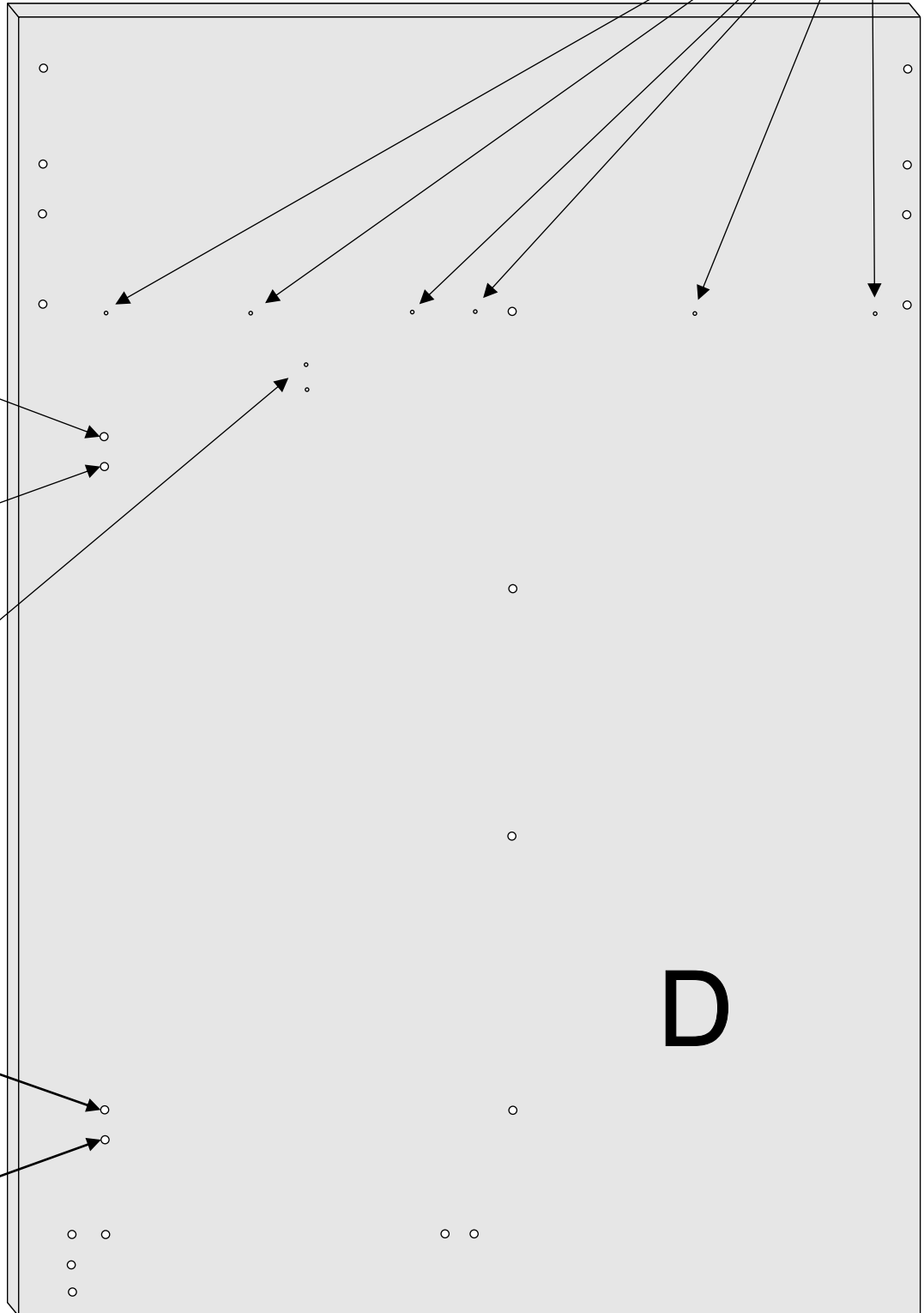
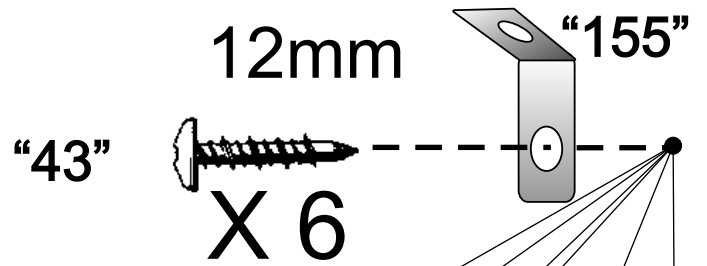

"206"

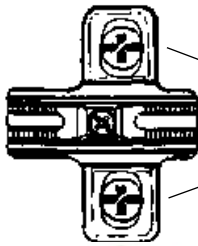

"44"
1 x 12mm



"118"

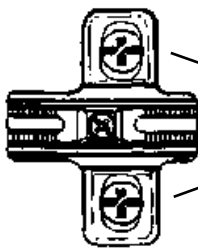

"206"

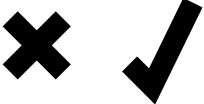
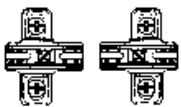



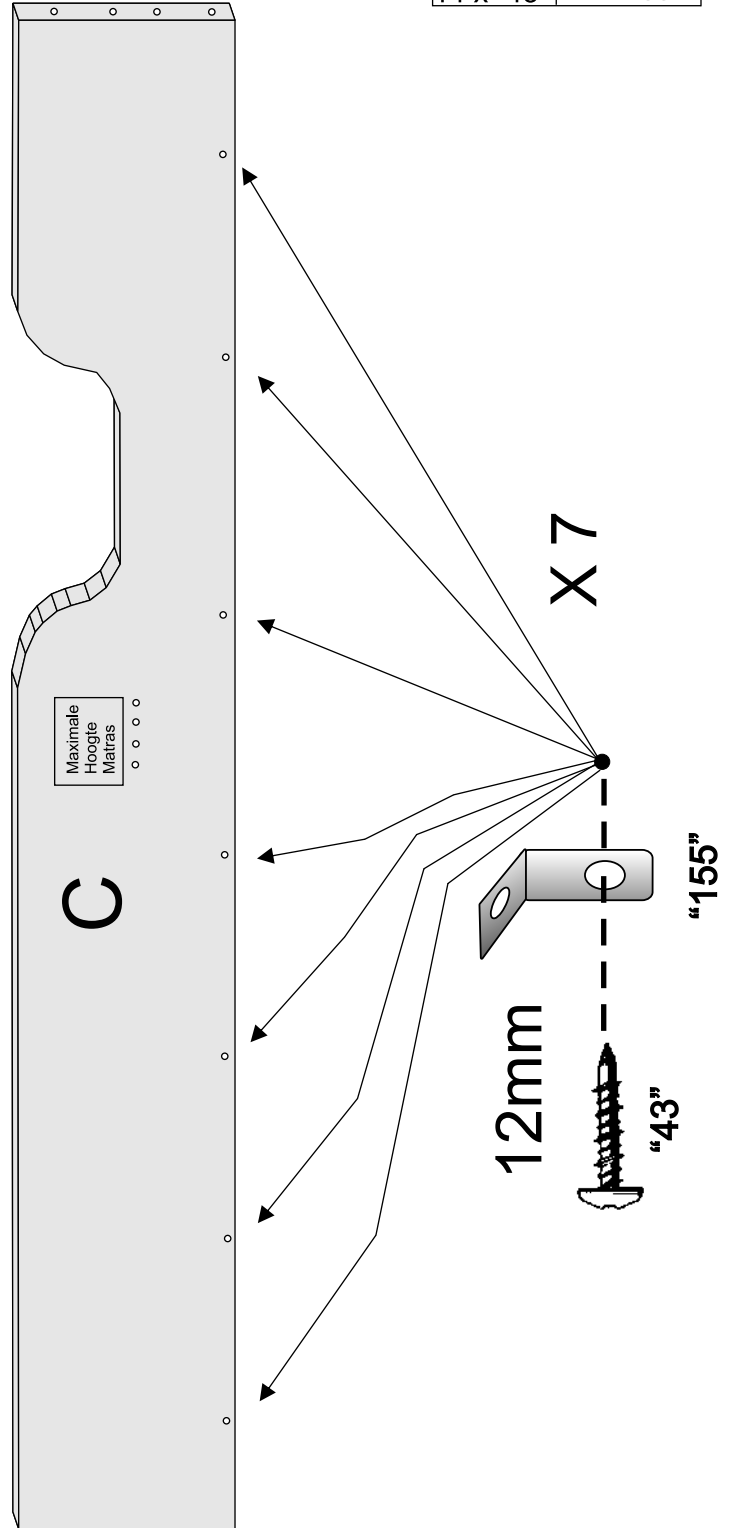
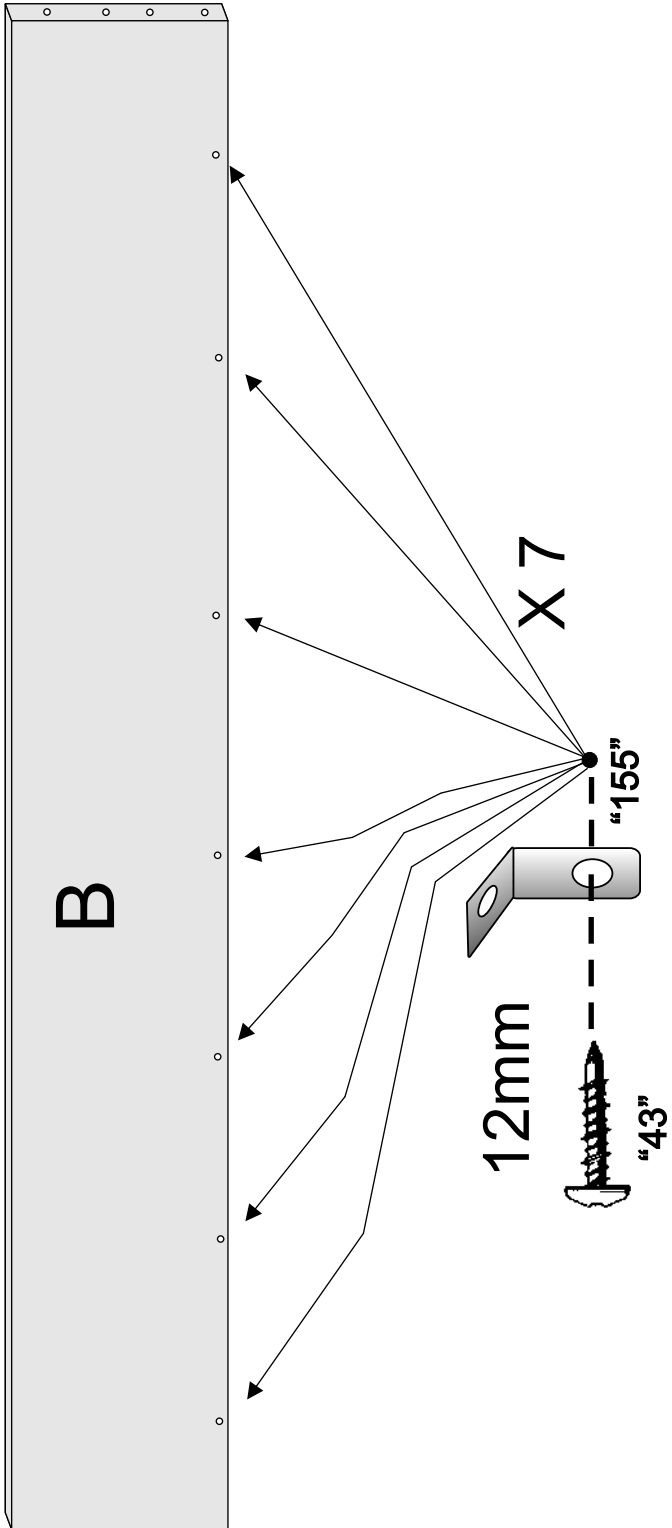
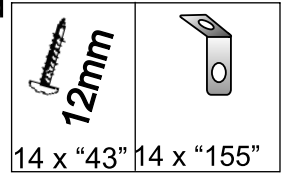

3

STEP 3 of 19 Lifestyle High Bed



4

STEP 4 of 19 Lifestyle High Bed

			
4 x "181"	4 x "182"	1 x "63"	4 x "44"

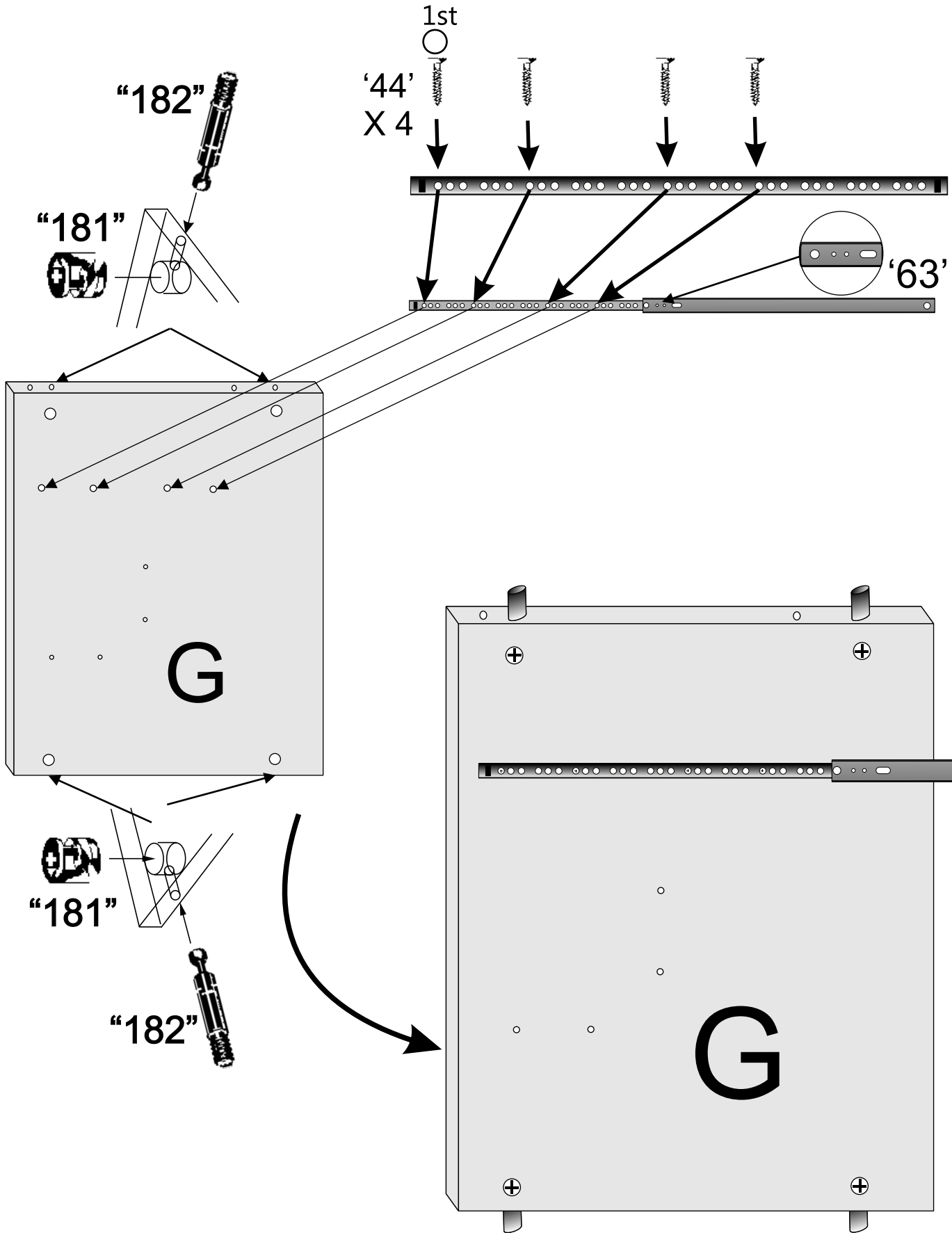







5

STEP 5 of 19 Lifestyle High Bed

1 x 12mm
"44"

"118"

 2 x "181"	 2 x "182"	 11mm 1 x "45" Goud Gold	 12mm 1 x "44"	 1 x "118"	 1 x "122"
--	--	---	---	--	--

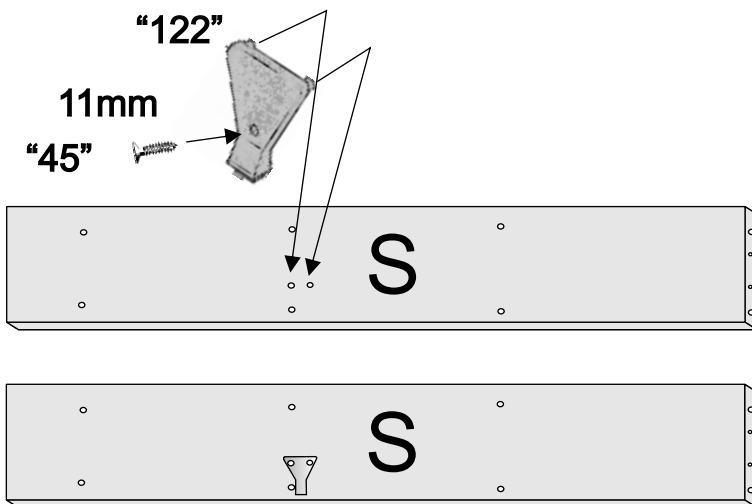
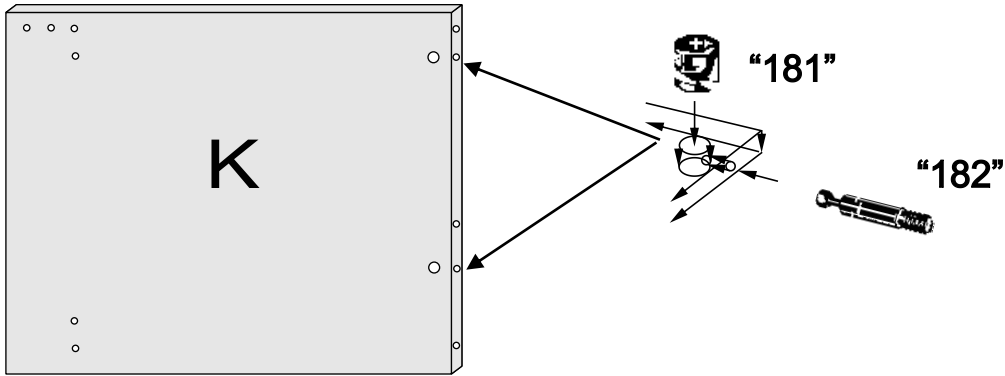
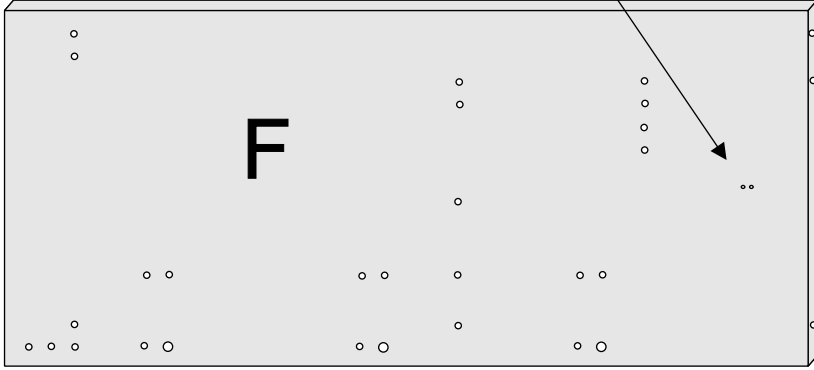





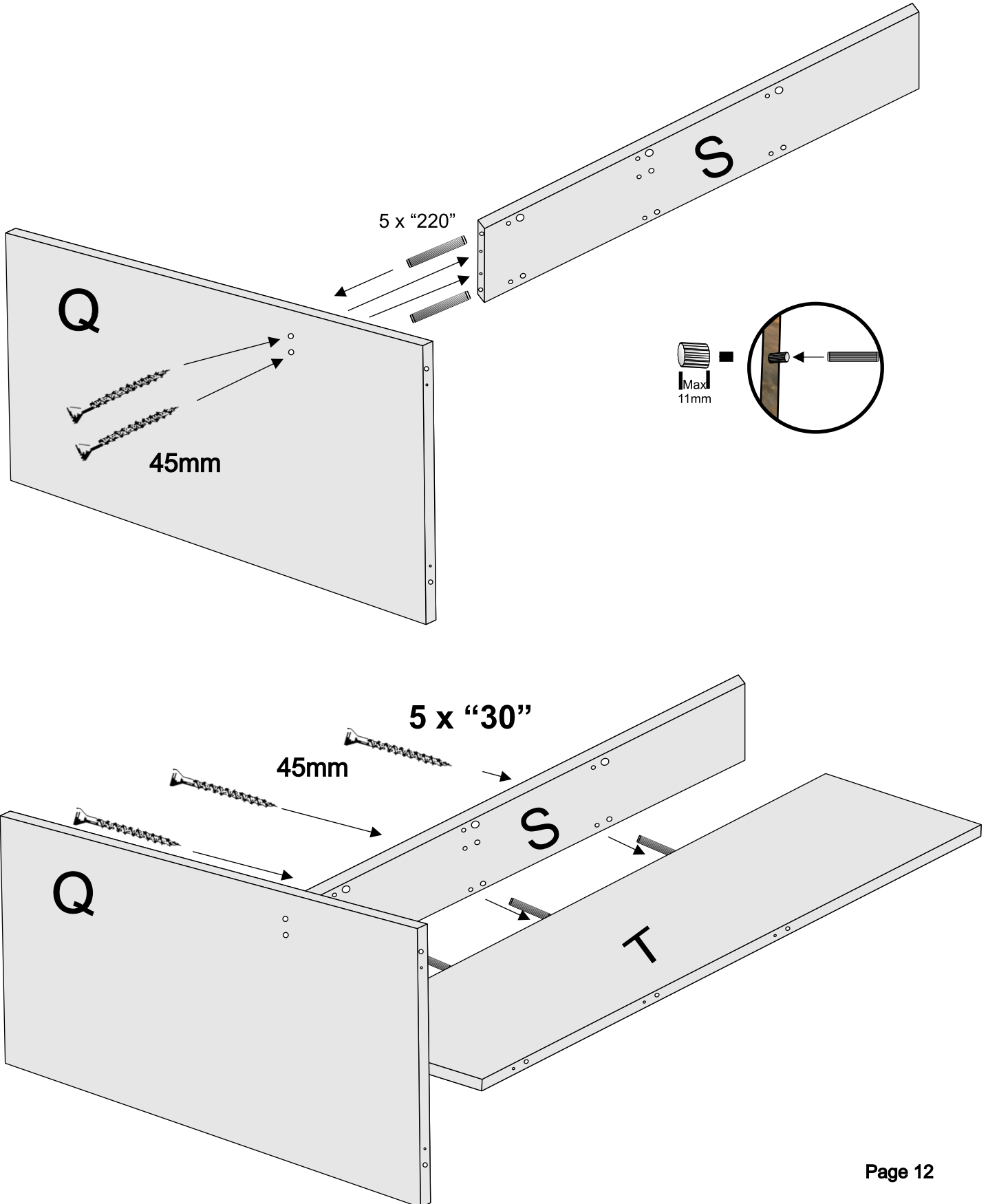
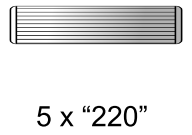

6

STEP 6 of 19 Lifestyle High Bed

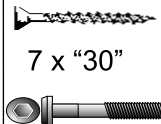

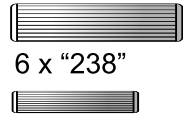
7

STEP 7 of 19 Lifestyle High Bed

 "219"	 7 x "30"  6 x "18"	 6 x "238"  5 x "220"	 6 x "23"	 1 x "20"
--	--	--	---	---

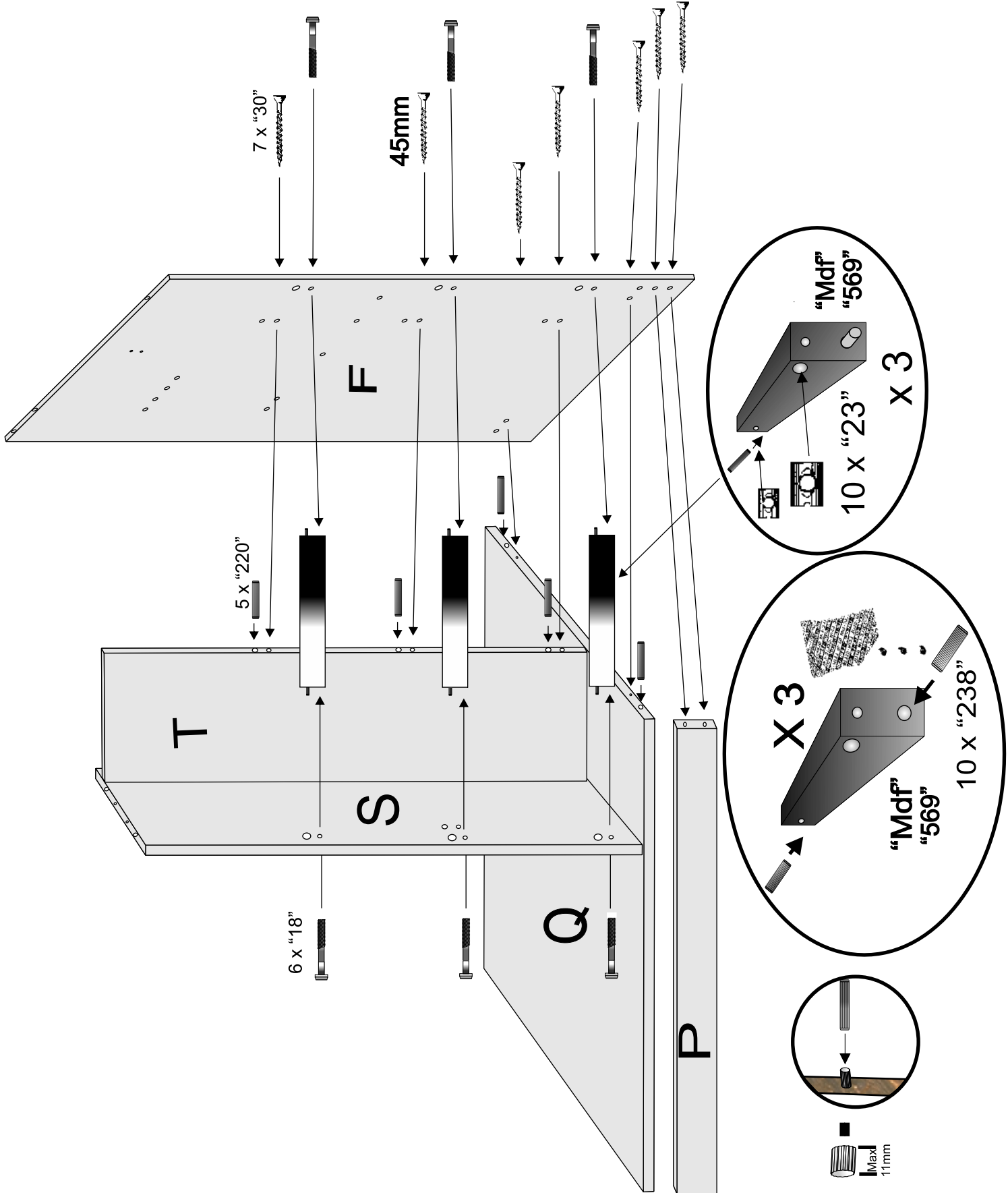

STEP 8 of 19 Lifestyle High Bed

8

45mm
4 x "30"

2 x "220"

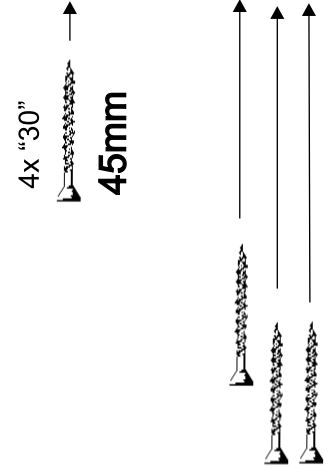
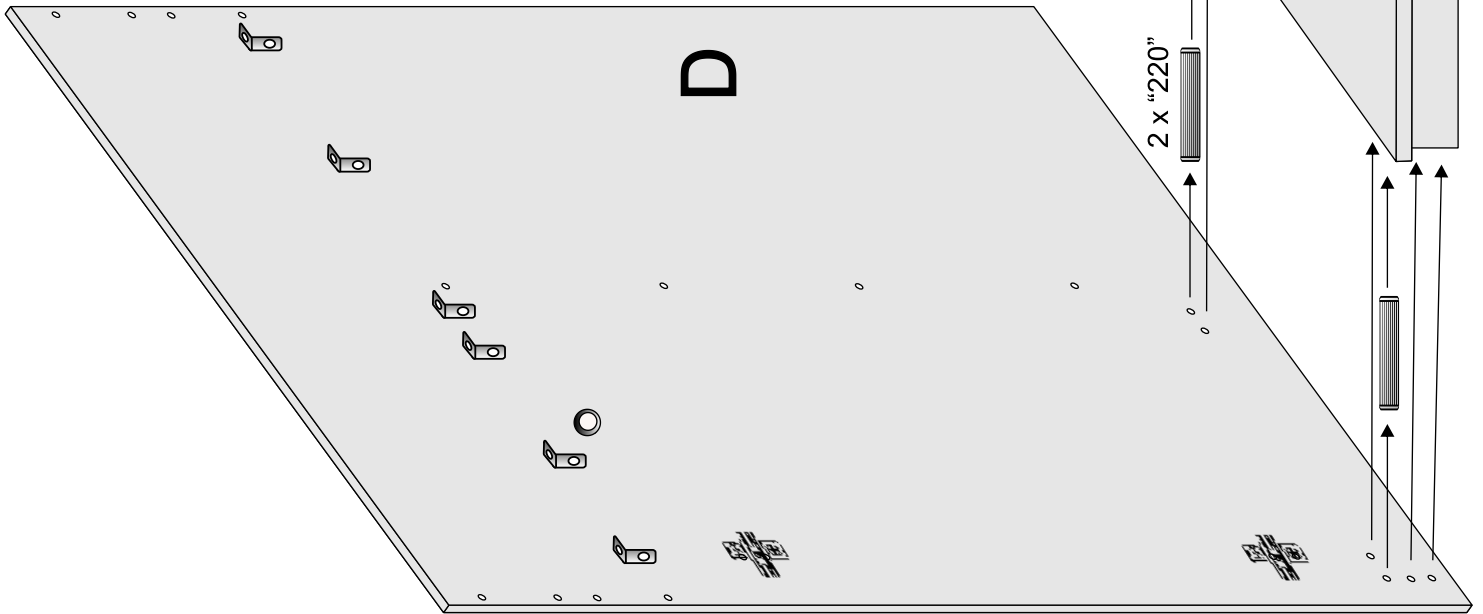
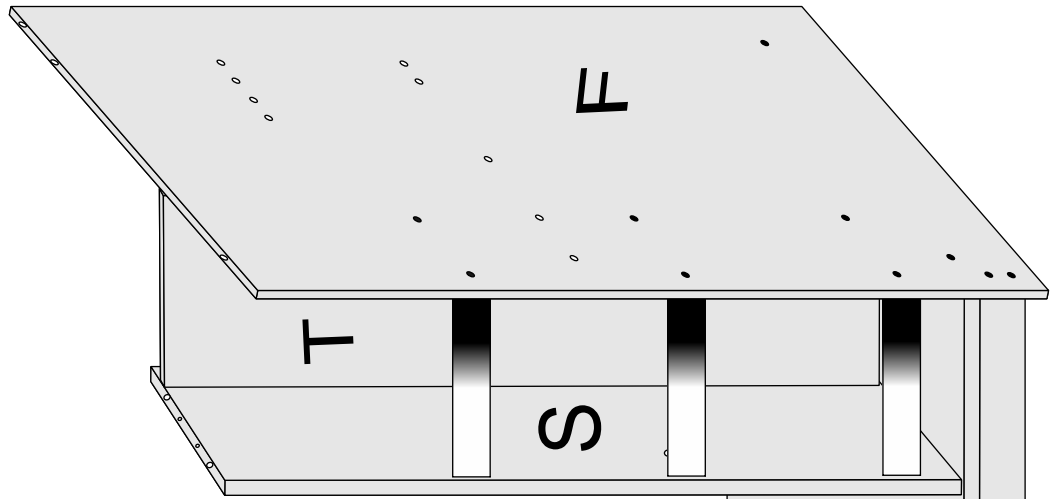
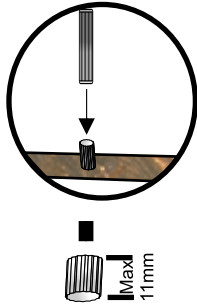

2 x "220"

9

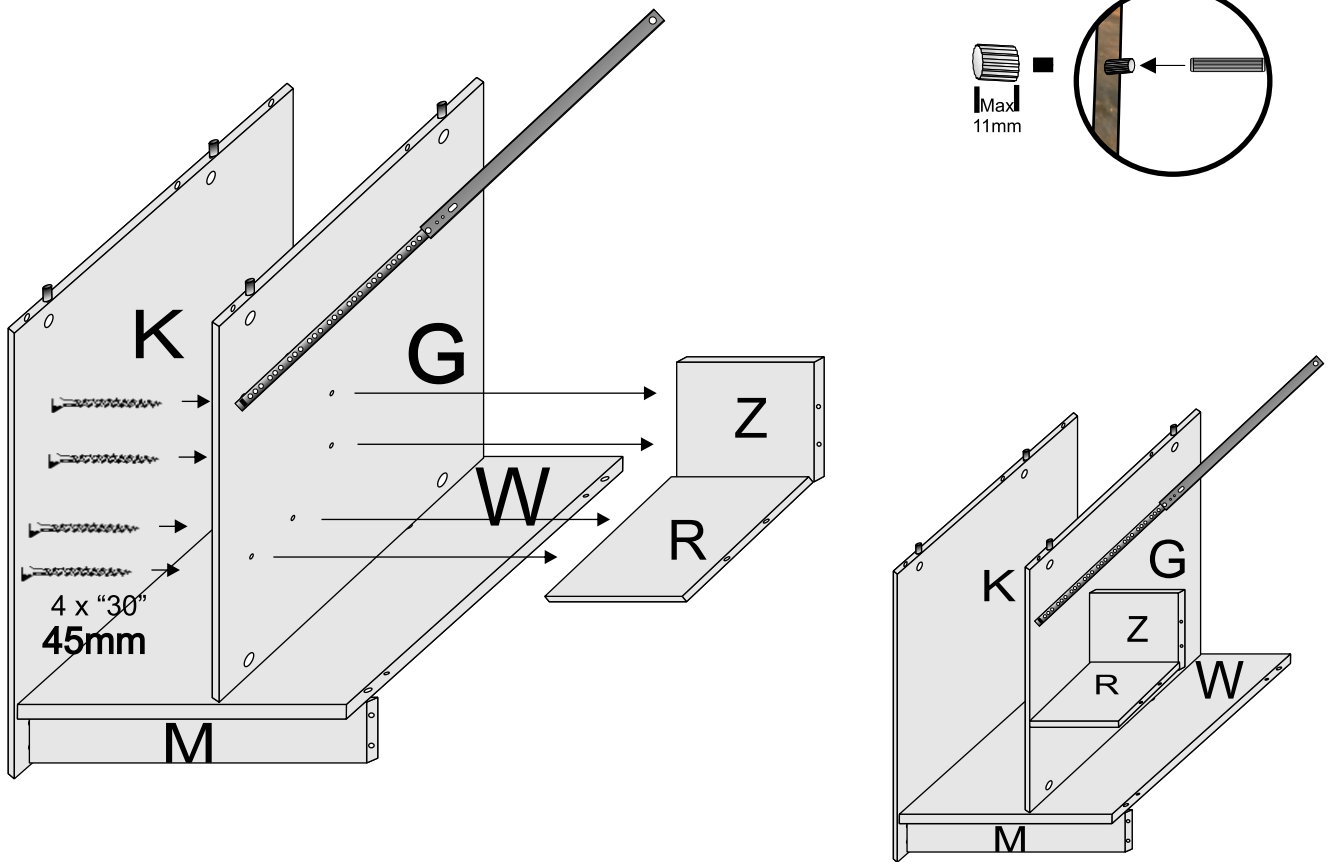
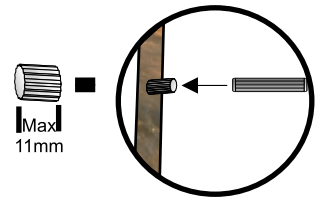
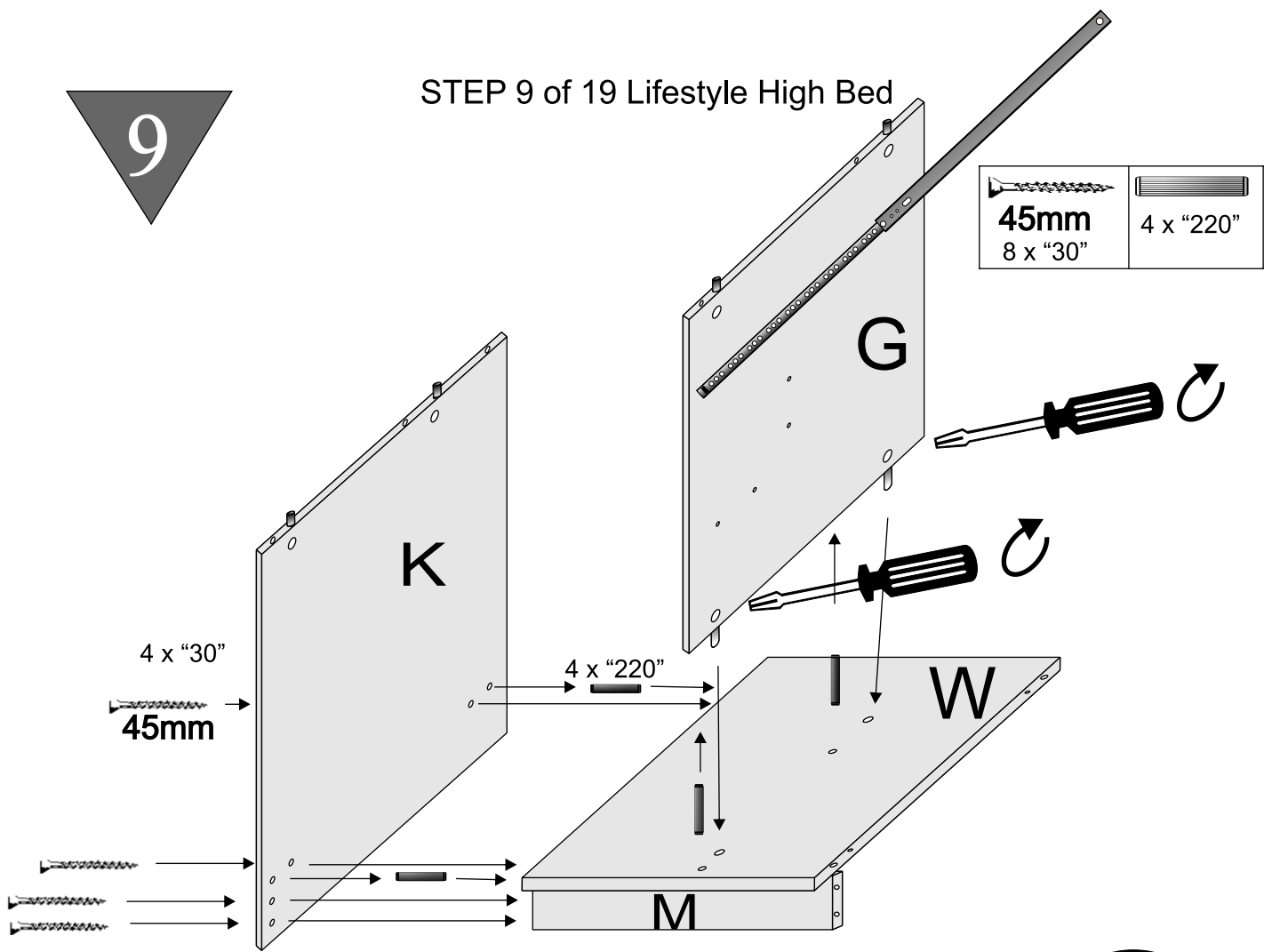

STEP 9 of 19 Lifestyle High Bed



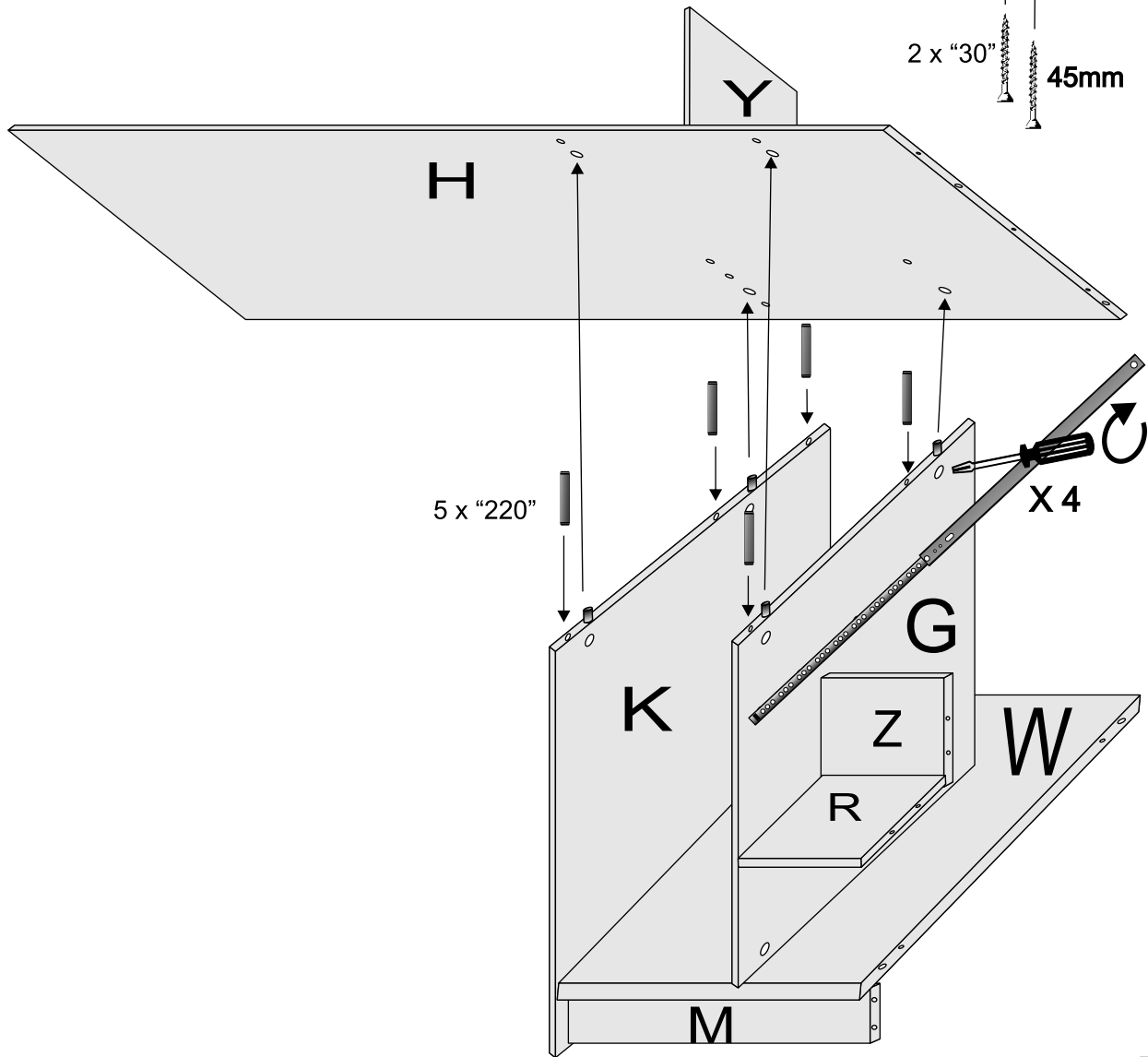
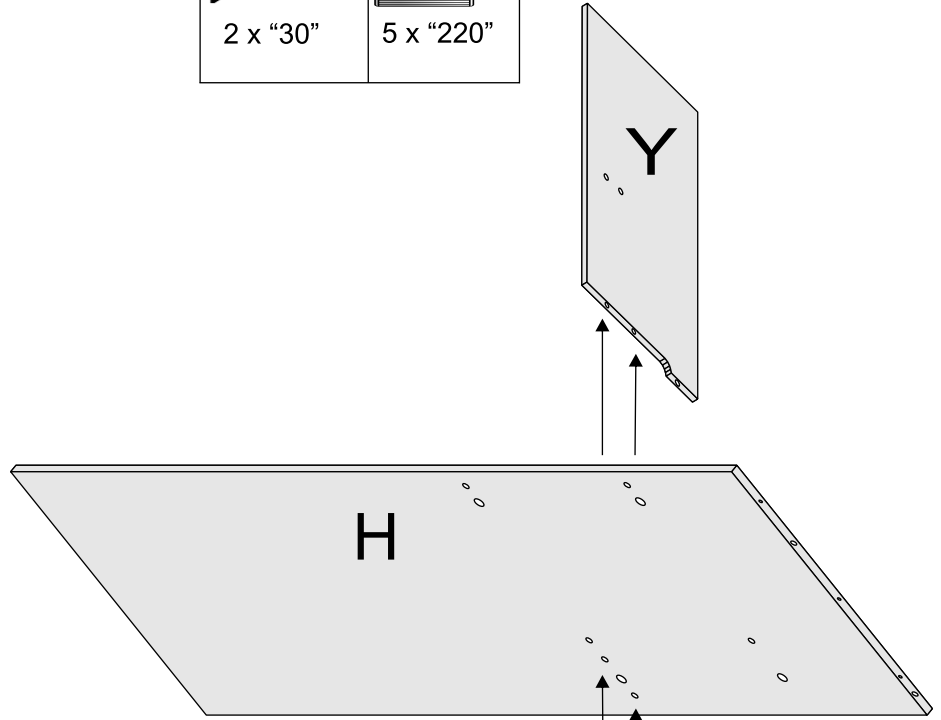
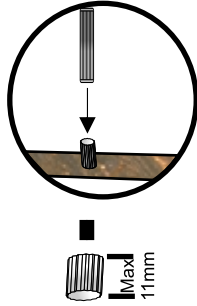
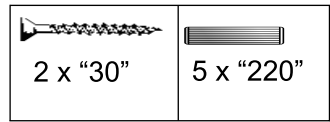

10

STEP 10 of 19 Lifestyle High Bed

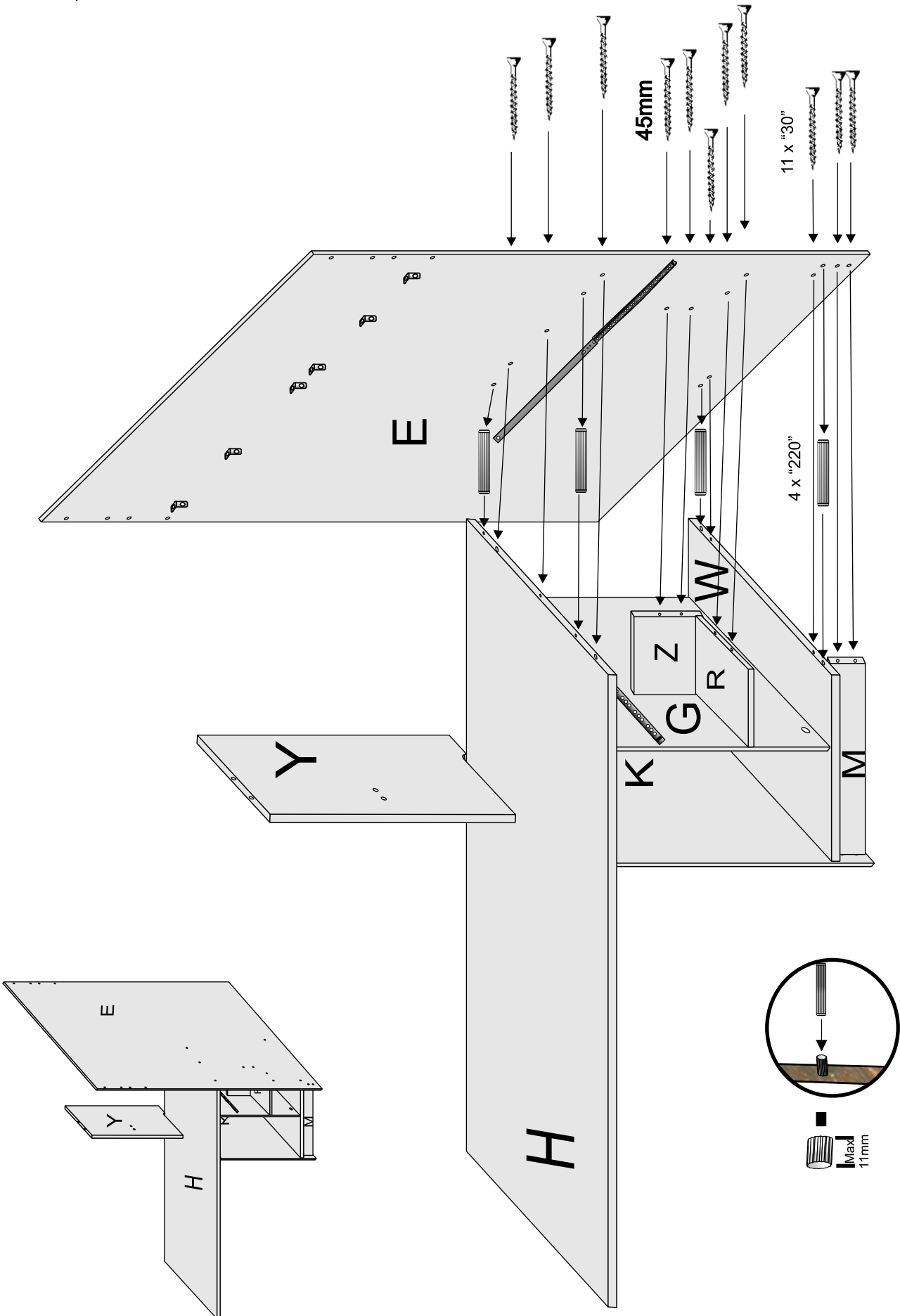

	
45mm 11 x "30"	4 x "220"

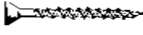

 45mm 7 x "30"	 6 x "220"
--	--

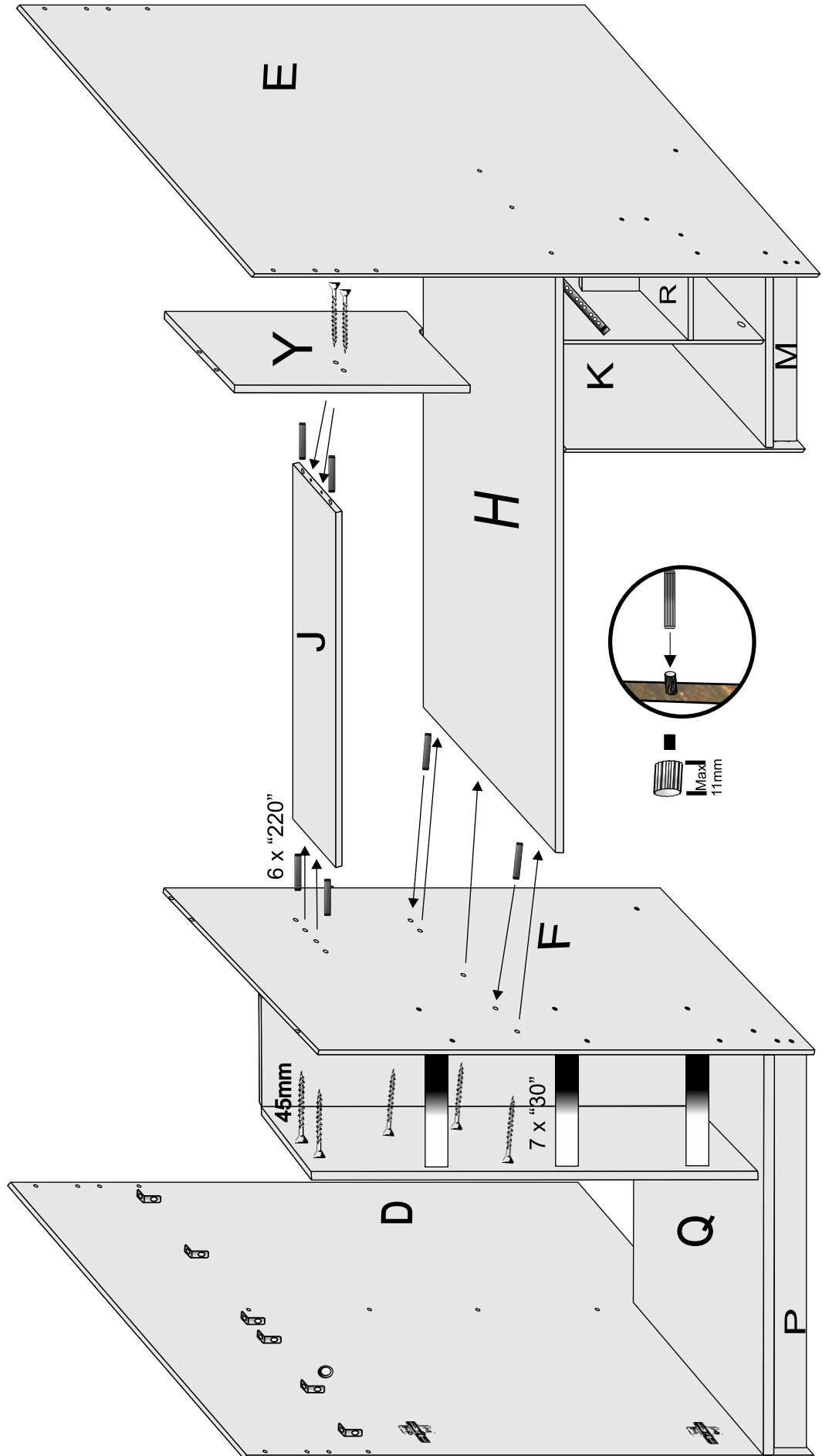

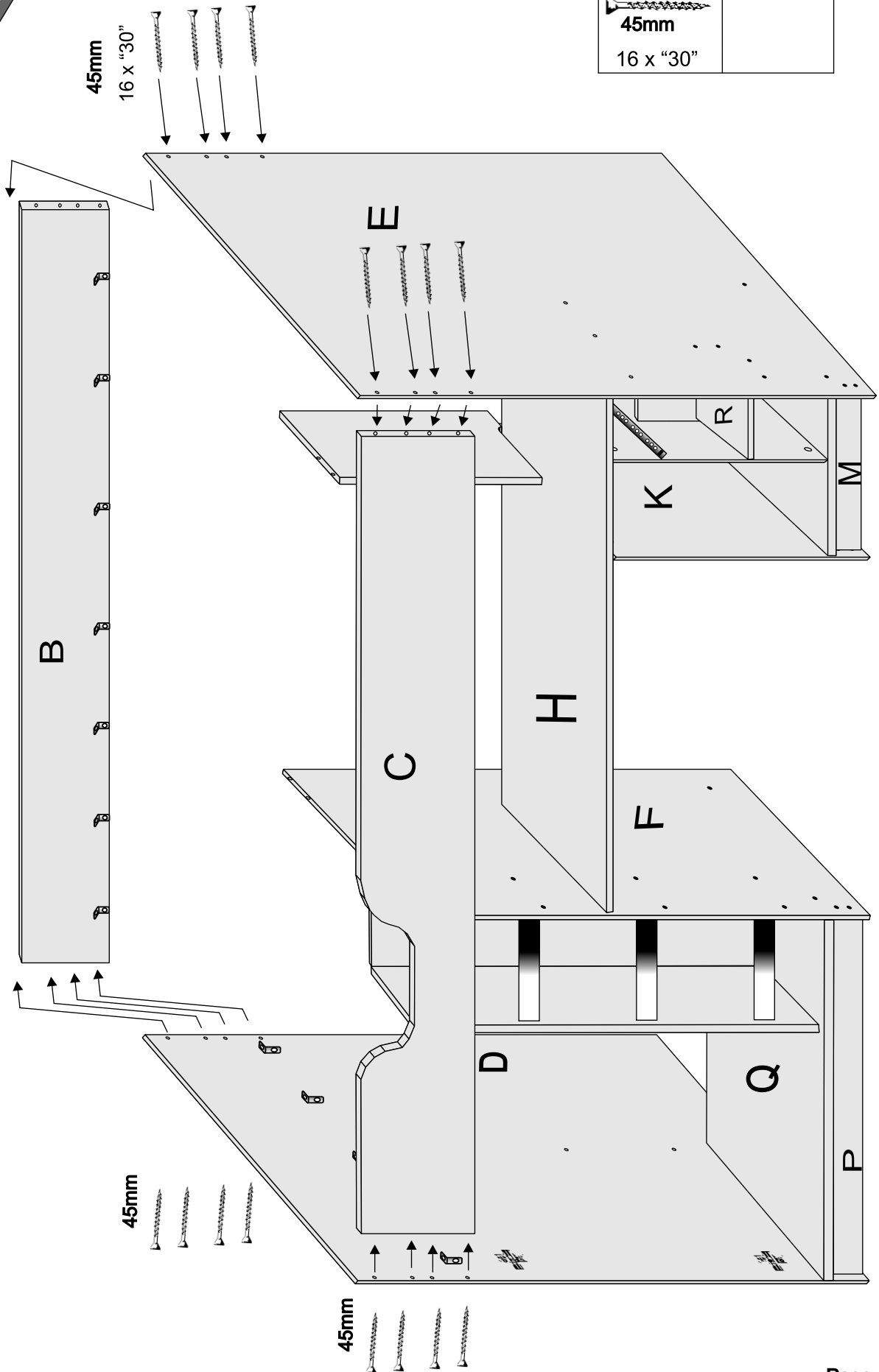
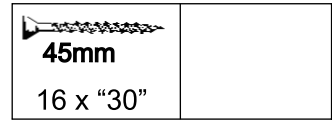



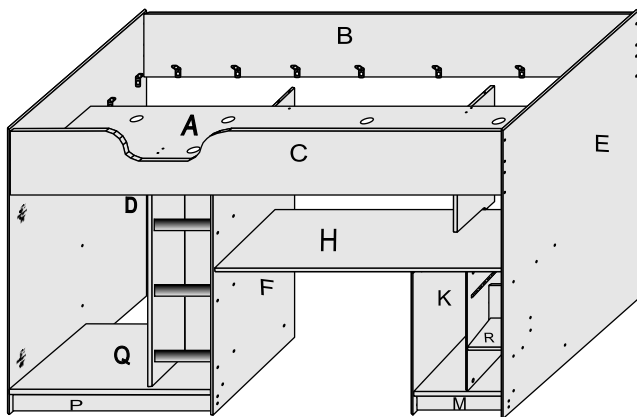
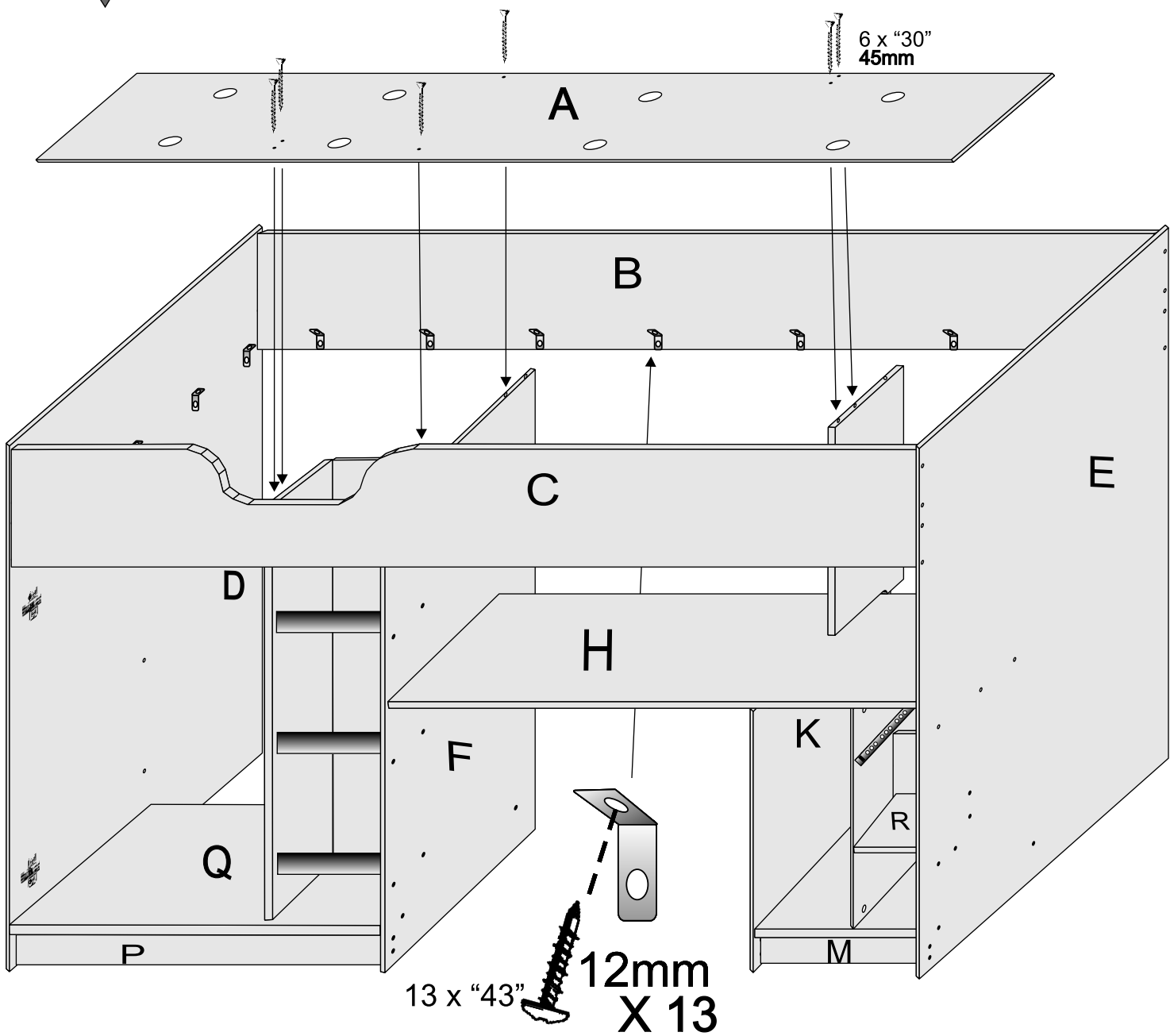
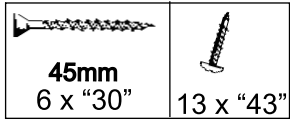

14

STEP 14 of 19 Lifestyle High Bed





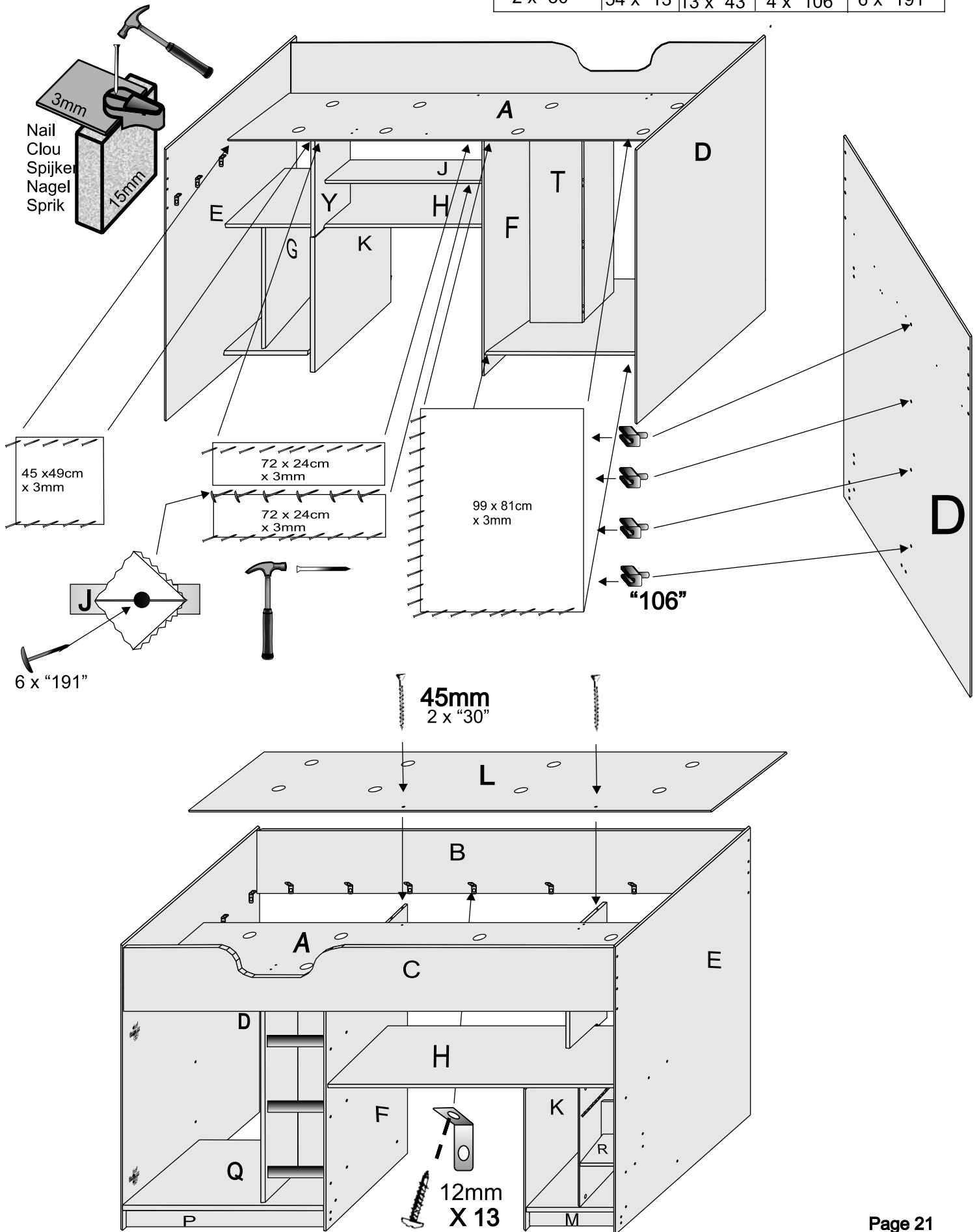

15

STEP 15 of 19 Lifestyle High Bed

 45mm	 12mm	 12mm		
2 x "30"	54 x "13"	13 x "43"	4 x "106"	6 x "191"



			
23mm 2 x "19"	4 x "44"	2 x "205"	1 x "131"

DOORS / DEURS

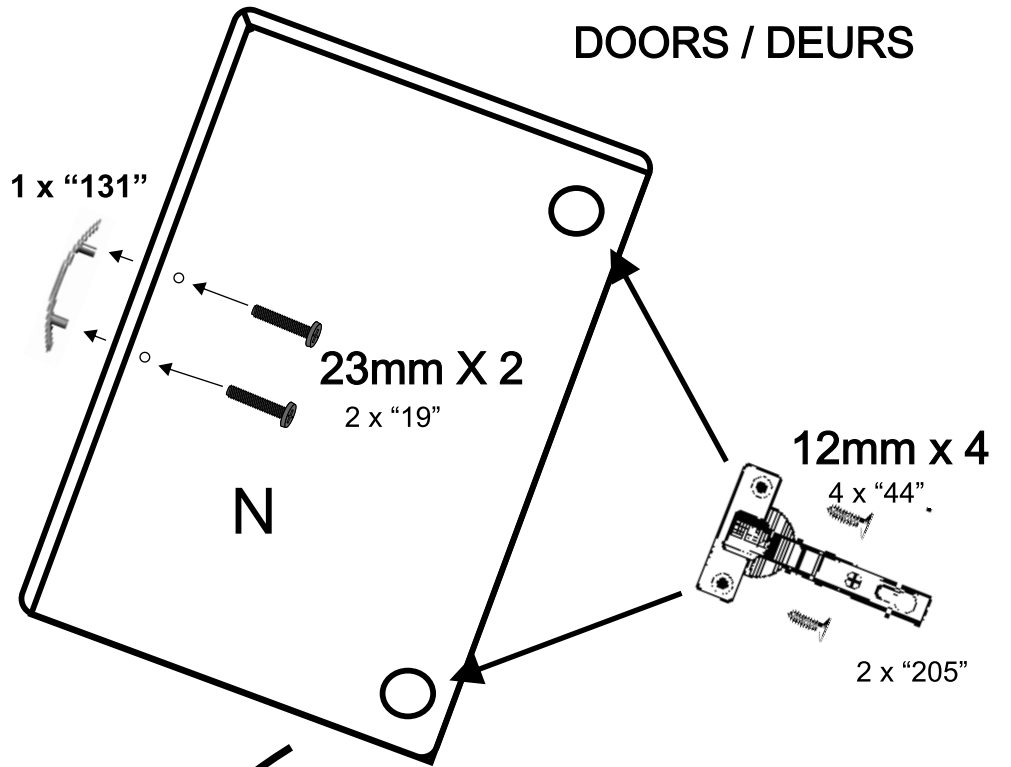

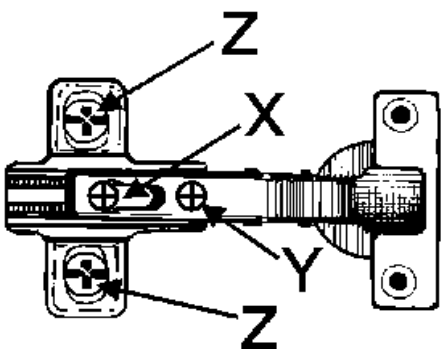
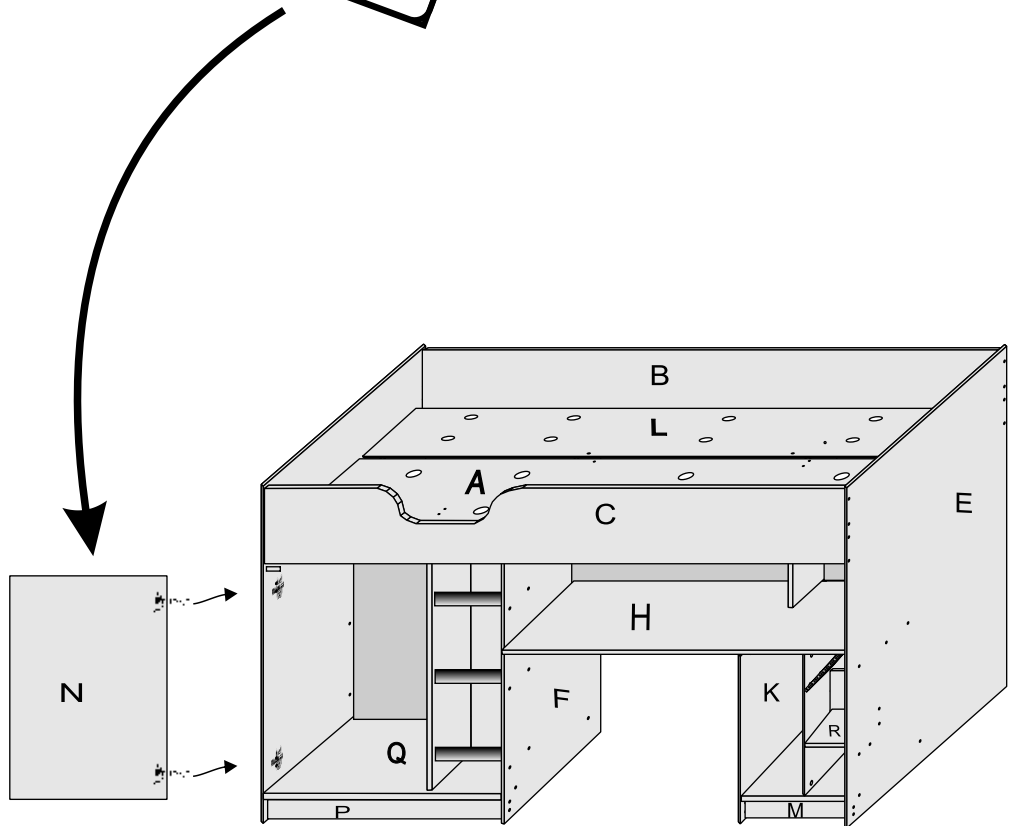
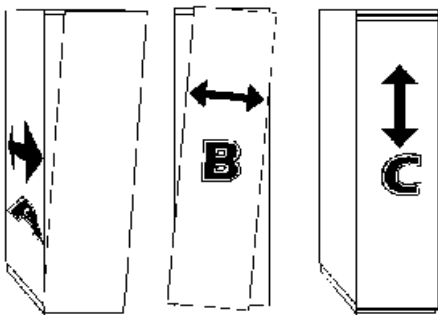

$X = A$ ↗↘
 $X + Y = B$ ↔
 $Z = C$ ↕



17

STEP 17 of 19 Lifestyle High Bed

 23mm 2 x "19"	 1 x "131"
---	--

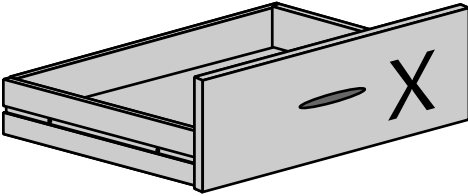
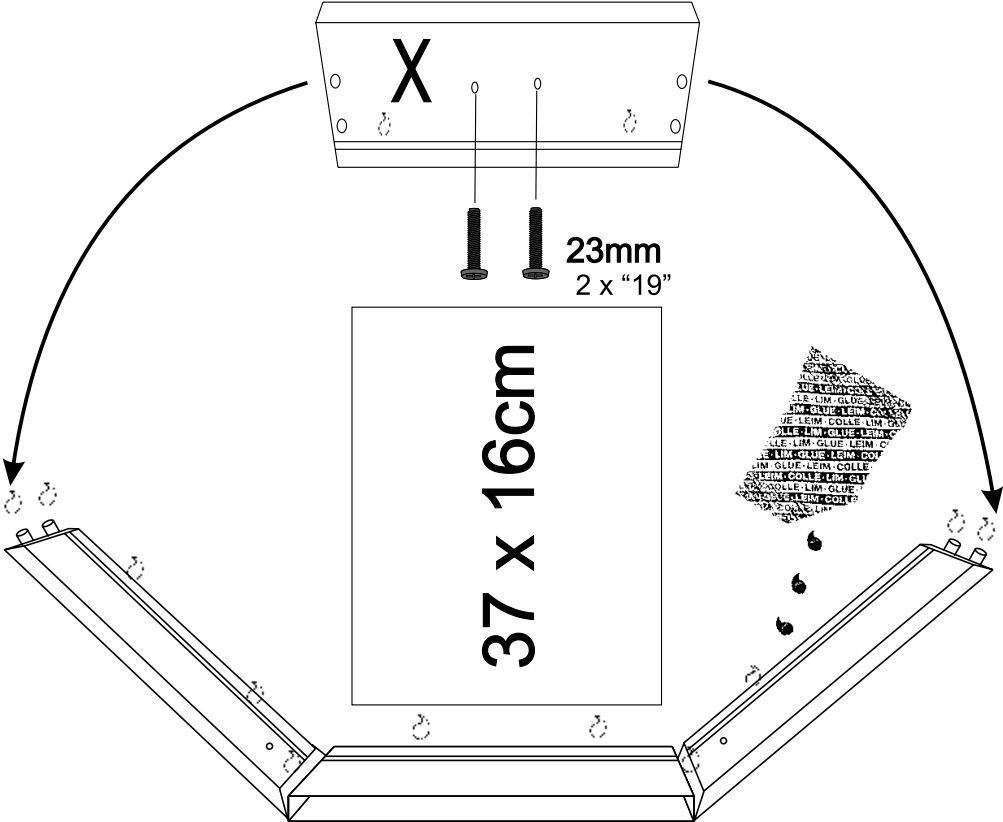

18

STEP 18 of 19 Lifestyle High Bed

10mm
2 x "47"

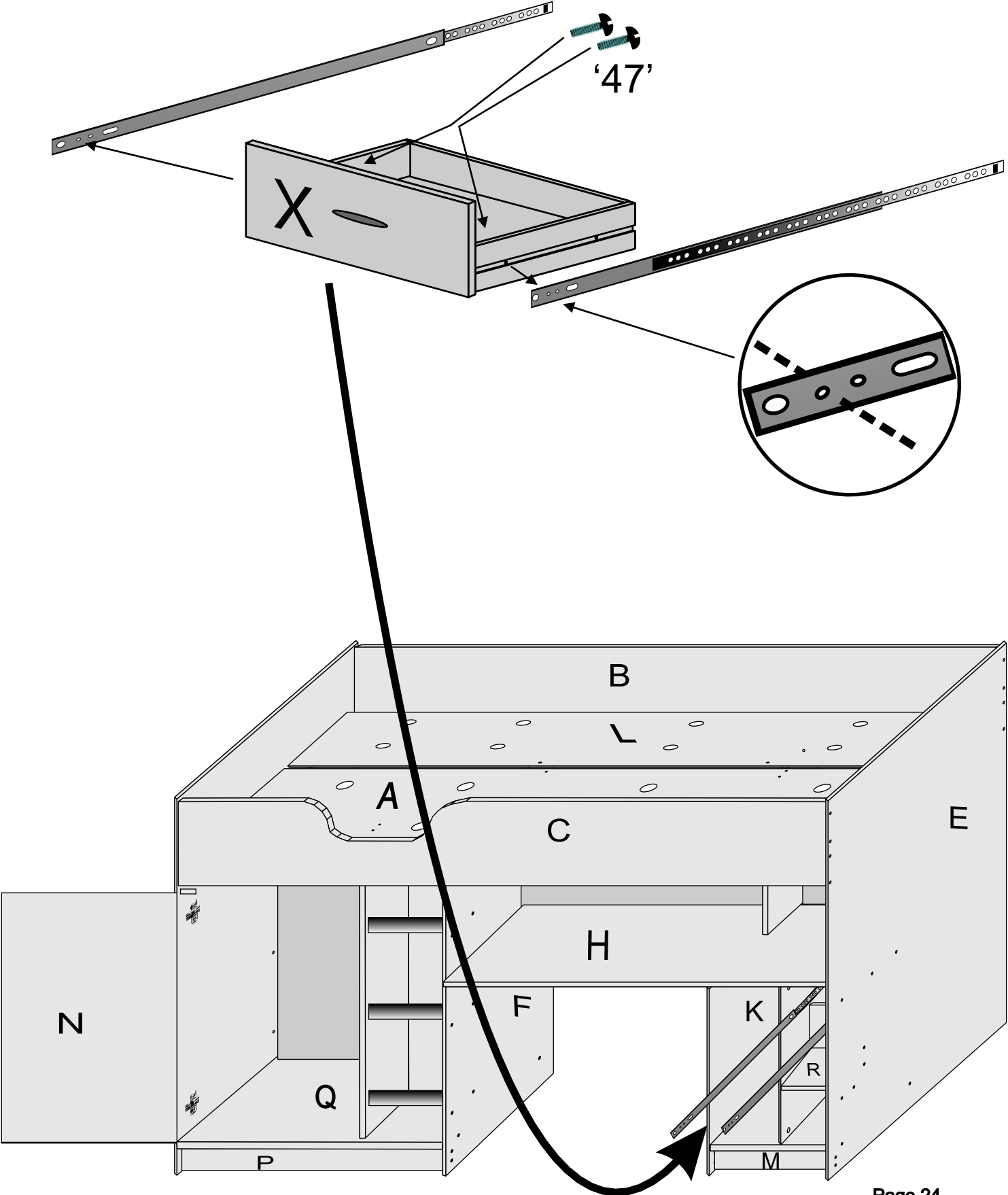

19

STEP 19 of 19 Lifestyle High Bed

78cm x "125"
2.2m x "534"

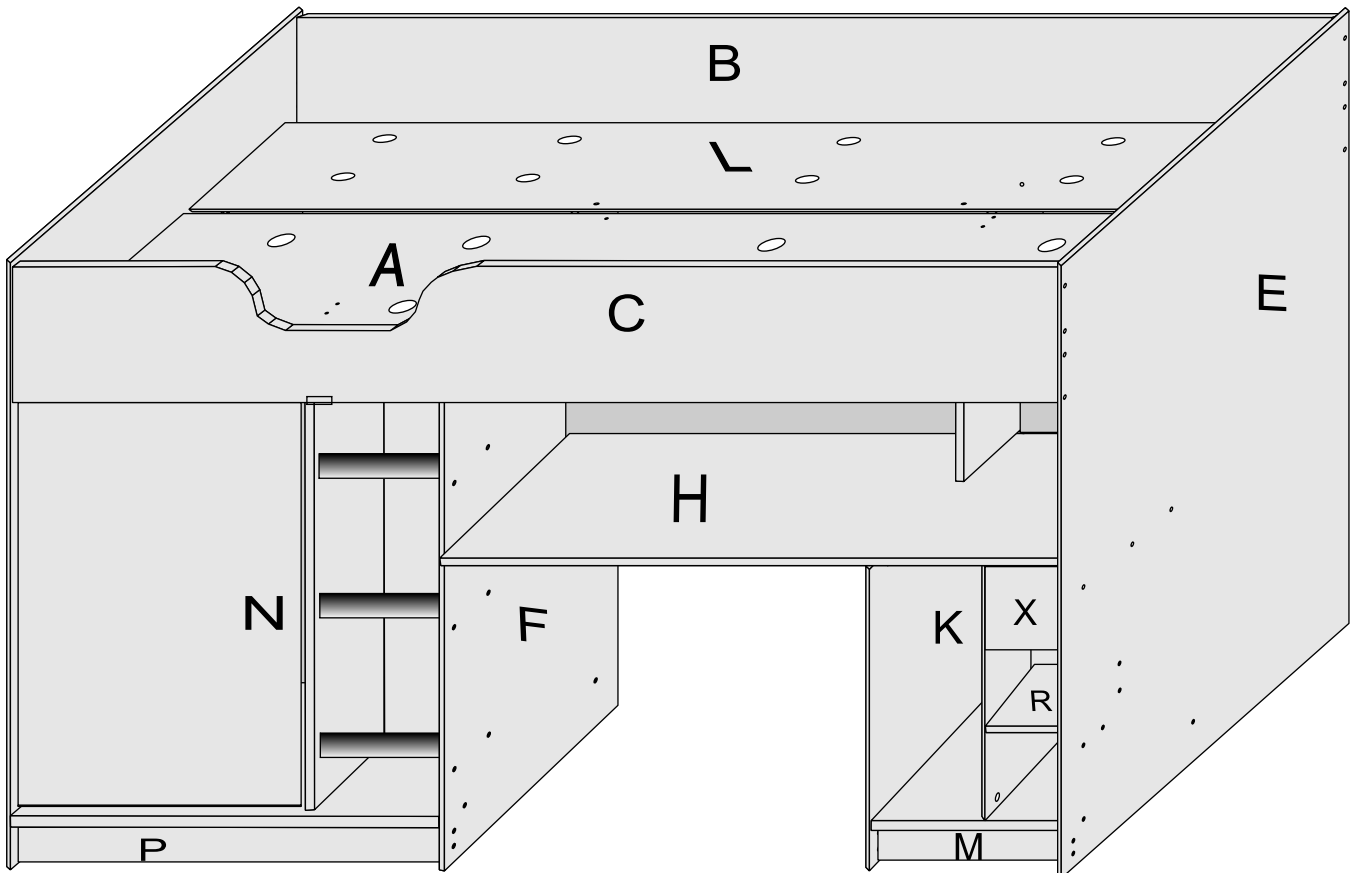
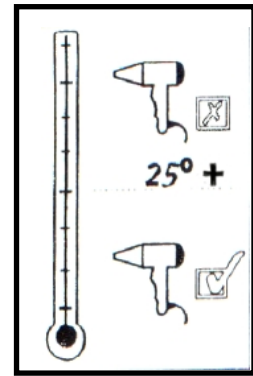
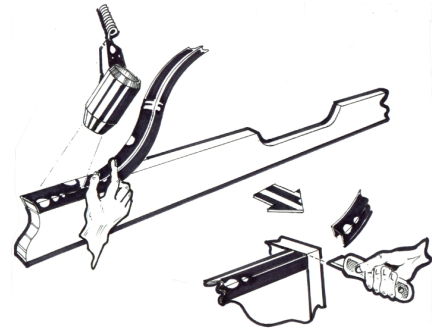
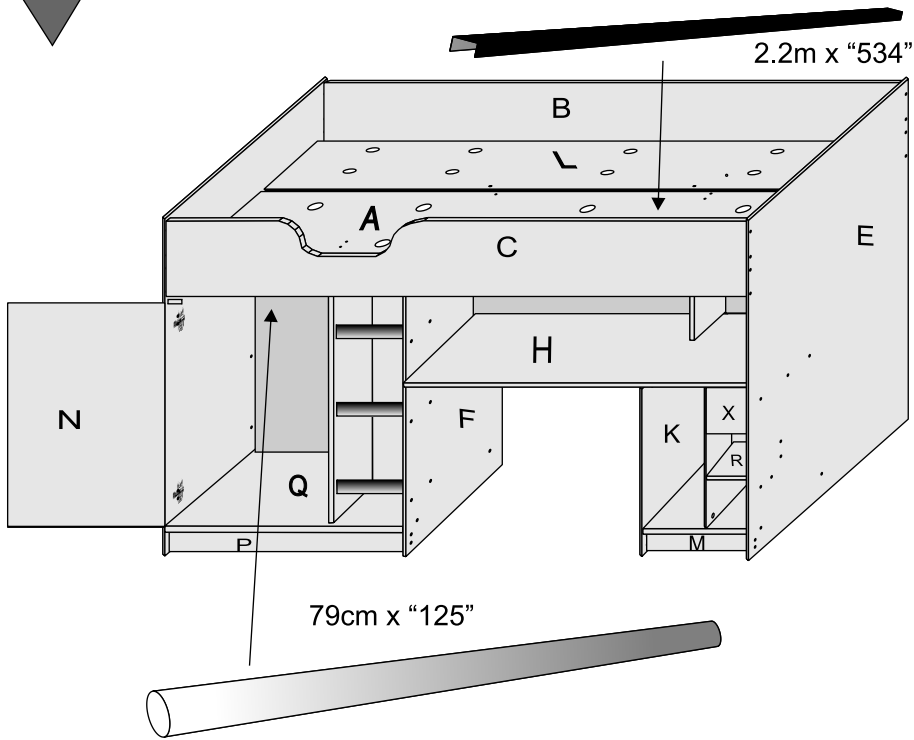

GB ONLY

WARNING!

To ensure that the safety rail is high enough above the mattress, a line is marked on the inside of panel 'C' this is the highest point that the mattress should reach. Be aware of the danger of young children (under 6) falling from the bed when assembled in its highest position. Make sure you show your child how to safely climb the ladder. DO NOT USE THE DESK TOP OR SHELF AS A LADDER.