

# Vienna 2 Door Wardrobe

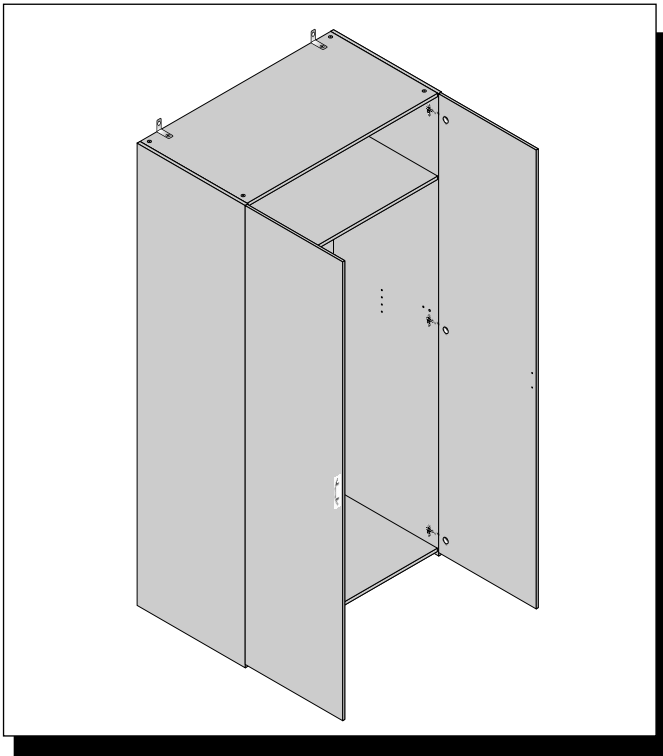

<b>A - 1</b>	<b>F - 1</b>	2 - 640 x 496 x 3mm
<b>B - 1</b>		2 - 1070 x 496 x 3mm
<b>C - 2</b>		
<b>D - 2</b>		
<b>DA - 1</b>		
<b>E - 2</b>		

961mm

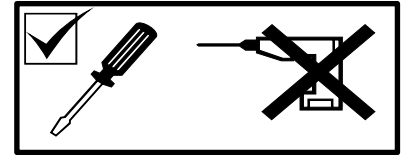

"124" x 2

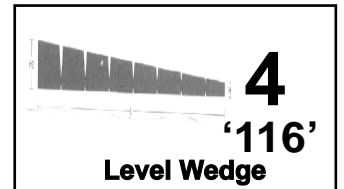
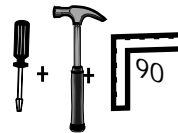

<p>23mm "19" 4 23mm x M4 Pan</p>	<p>"85" 4 8mm Plug</p>	<p>"118" 4 Oval Rail Support</p>	<p>"220" 12 6mm Dowels x 38mm</p>	<p>"17" Nail Guide 7.5mm</p>	<p>12mm "44" 12 12 x 3.5mm Csk Pozz BZP</p>	<p>"181" 16 Tius Cam</p>	<p>"206" 6 0mm Hinge Plate</p>
<p>"74" 20 5mm Plug</p>	<p>"92" 4 6mm Plug</p>	<p>"131" 2 Chrome 64mm Bow Handle</p>	<p>"13" 75 Panel Pins</p>	<p>12mm "43" 14 12x4mm Pan BZP Pad</p>	<p>"155" 2 DT 484</p>	<p>"182" 16 Tius Dowel</p>	<p>"208" 6 0 Crank 26mm Hinge</p>

DUE TO THE SIZE OF THE WARDROBE BUILD IT IN THE ROOM YOU INTEND TO USE IT IN

# PANEL INVENTORY PAGE 1 OF 2

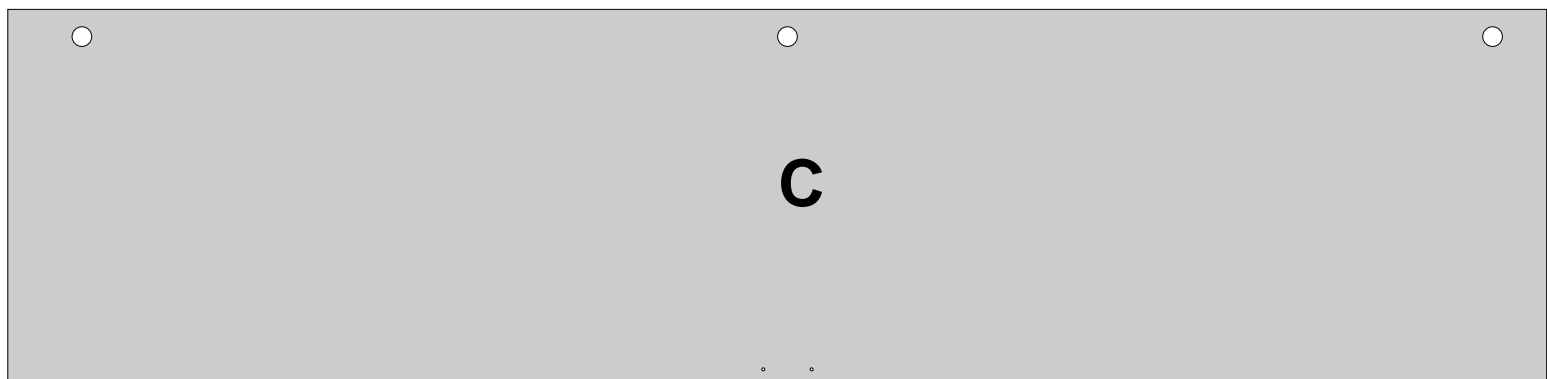
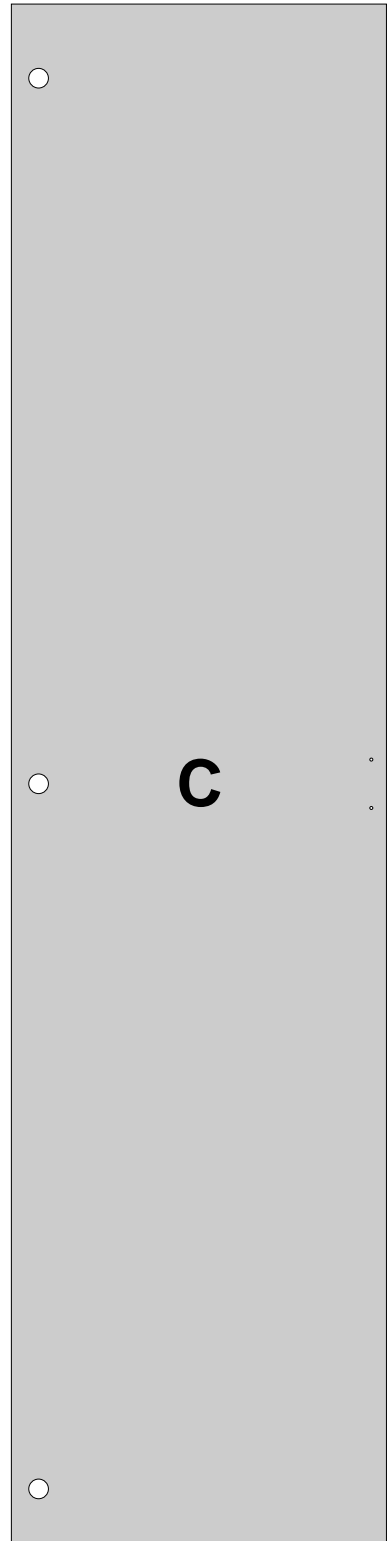
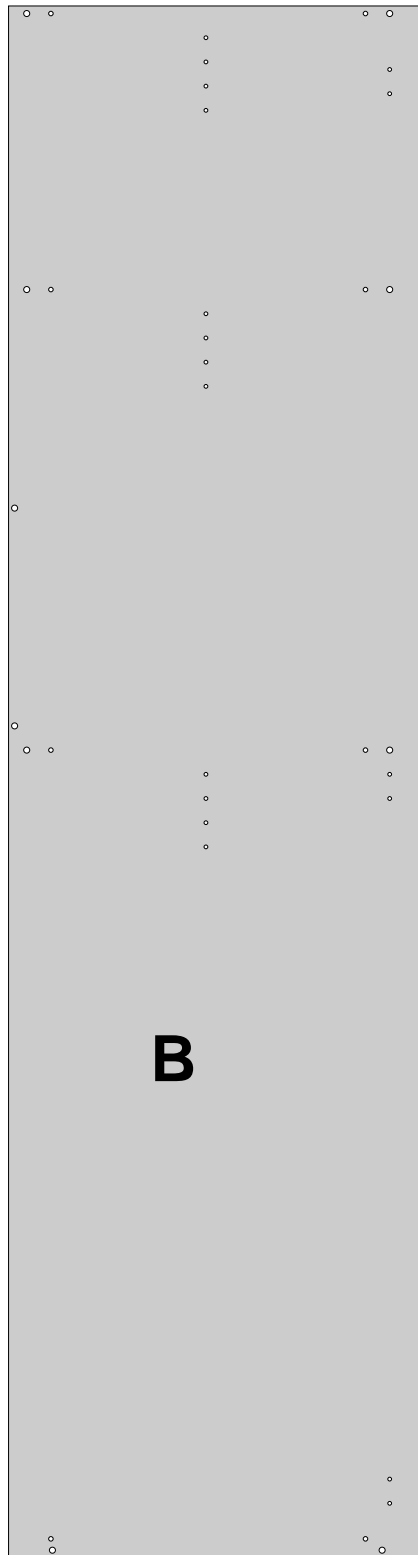
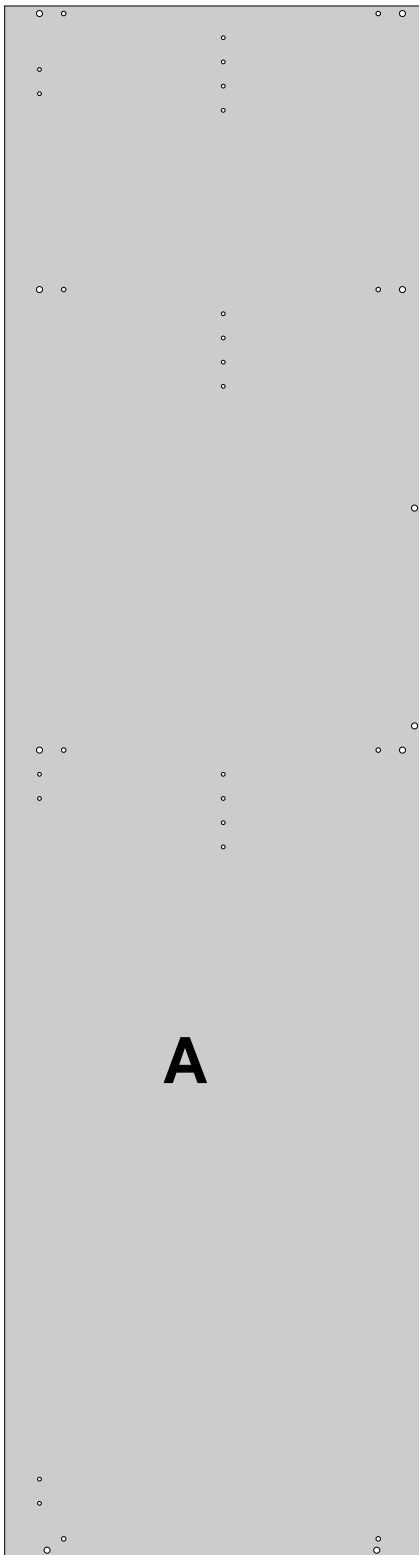

# PANEL INVENTORY PAGE 2 OF 2

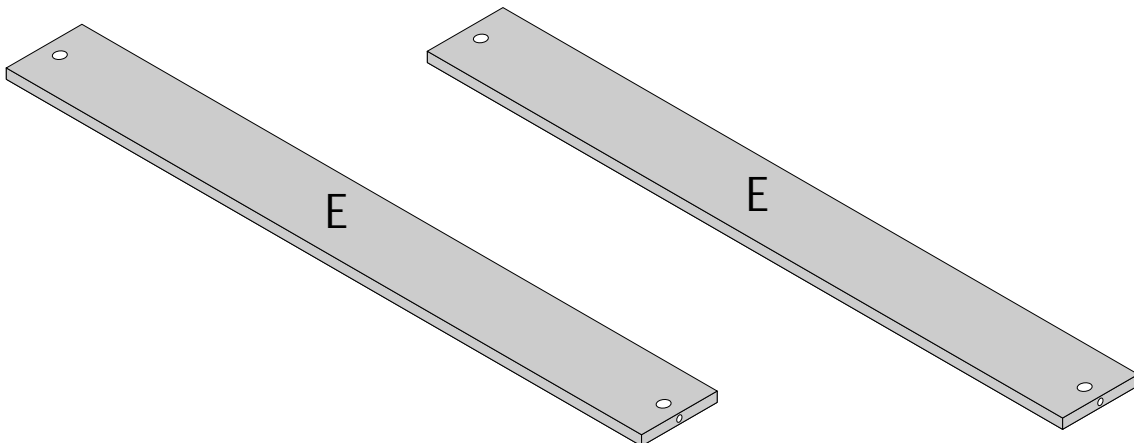
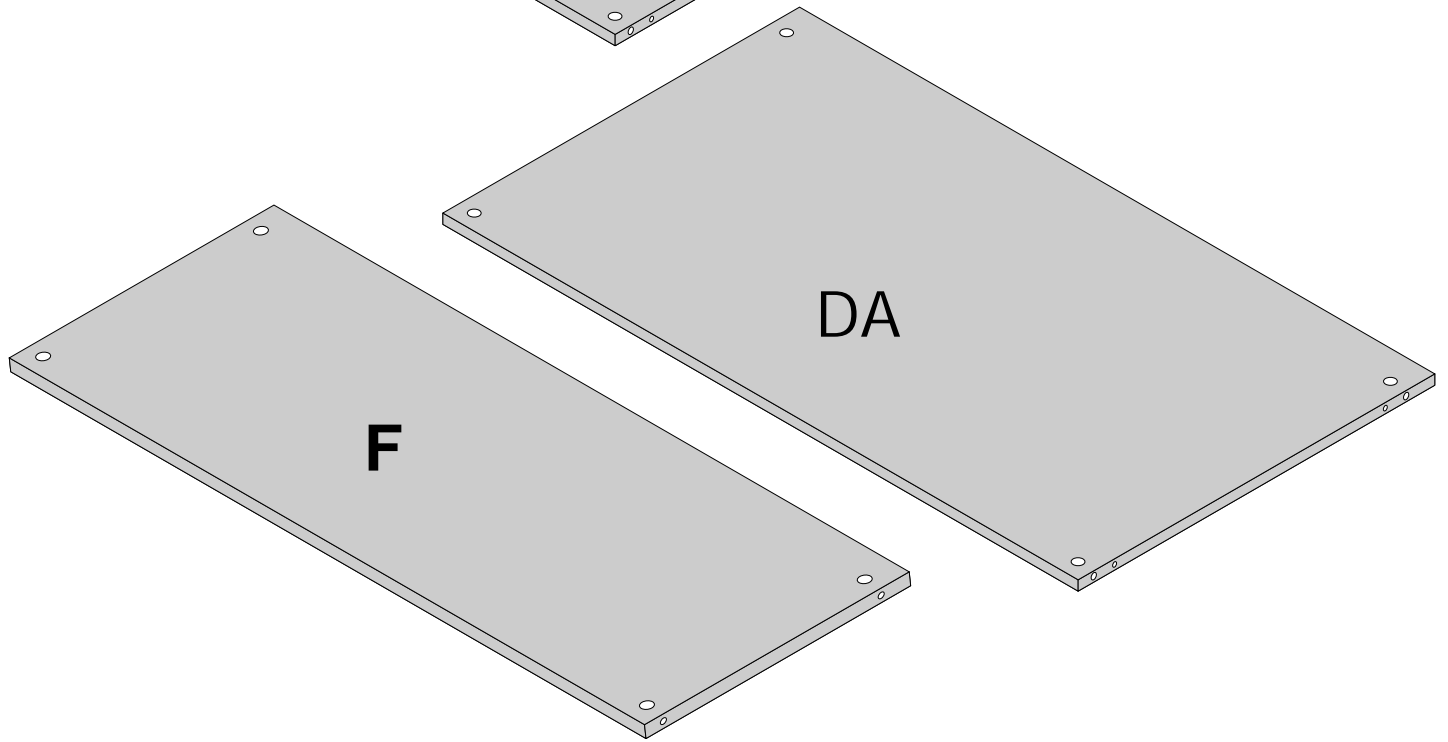
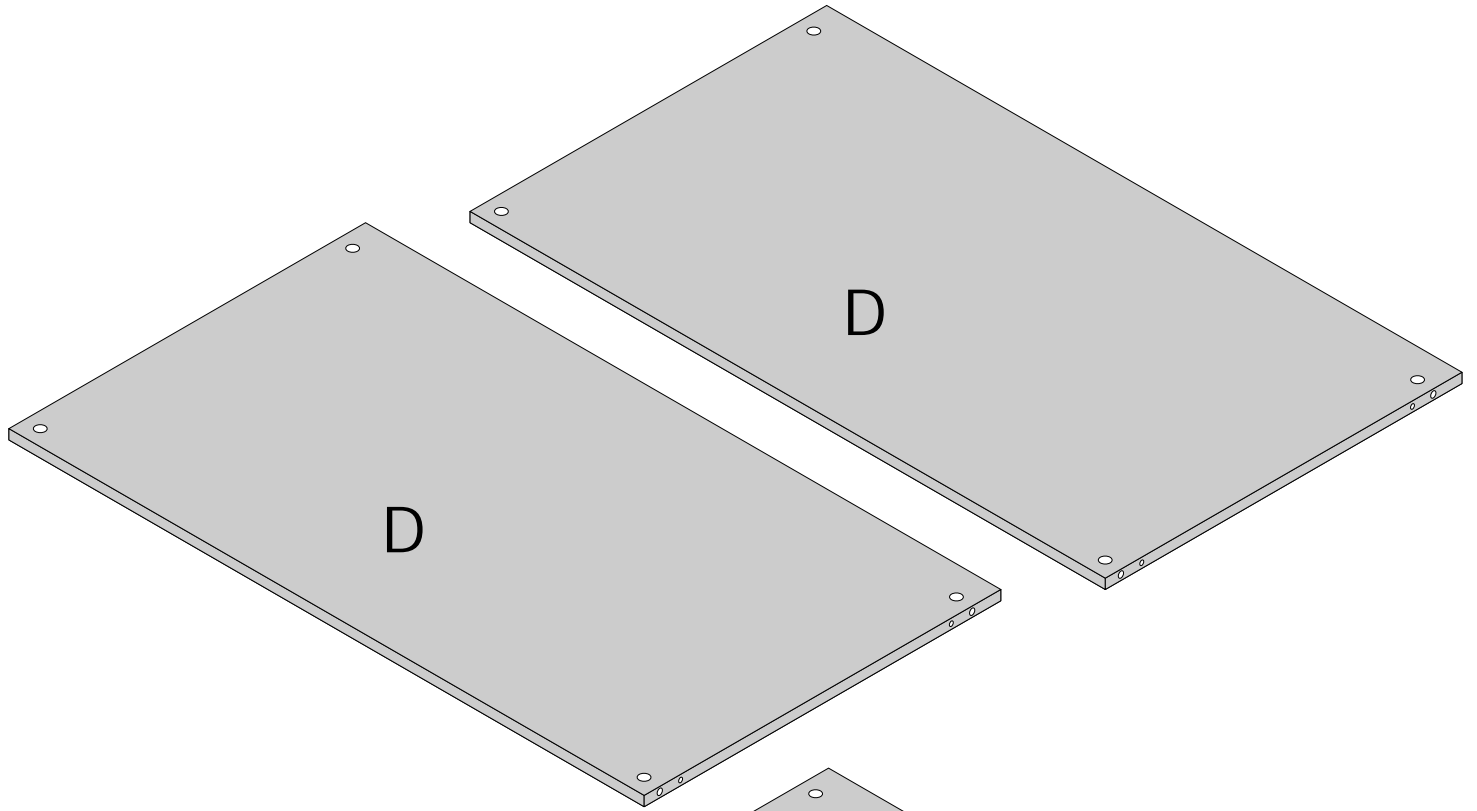

6x"206"

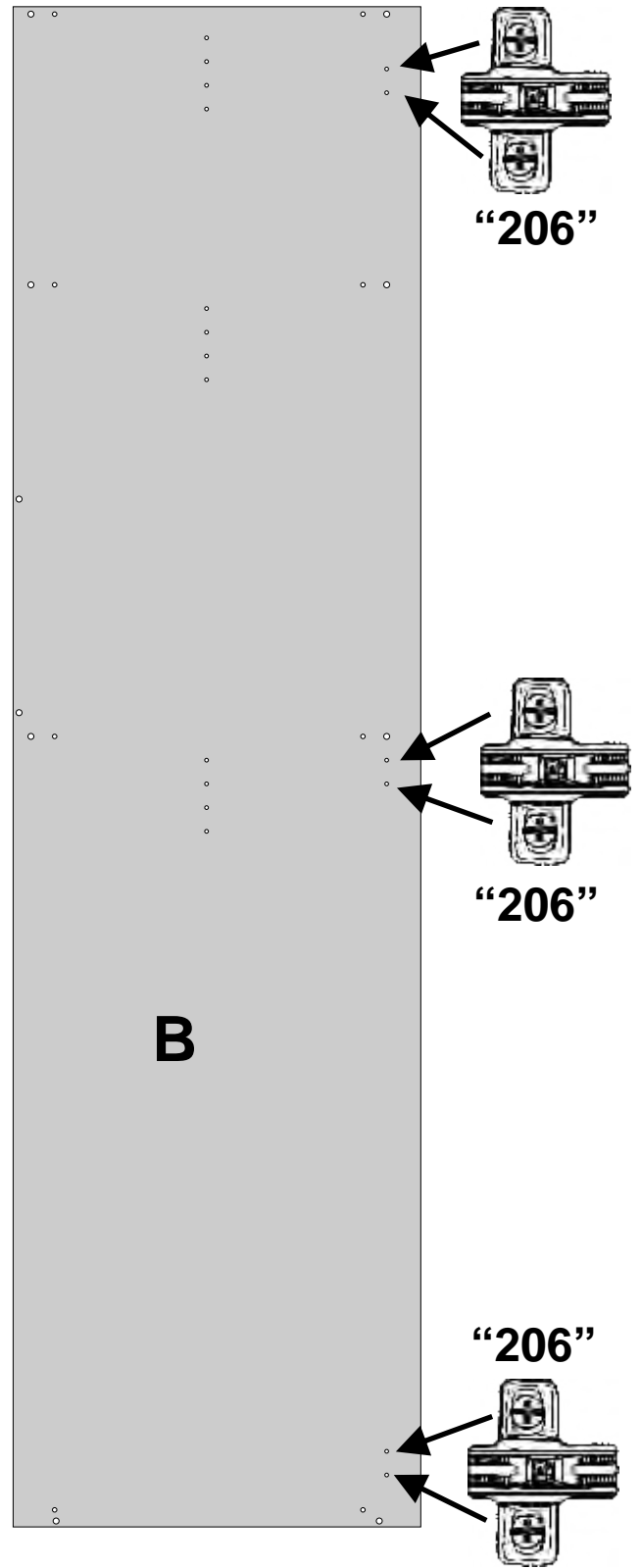
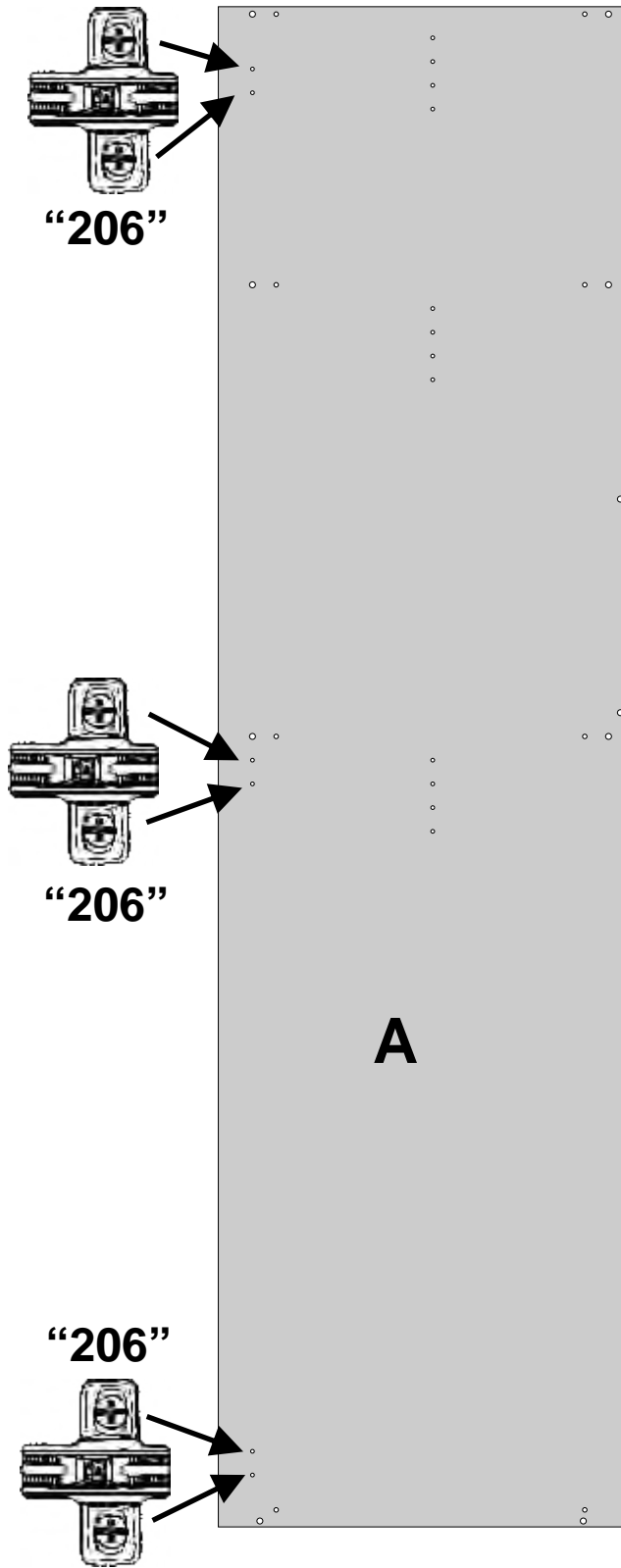

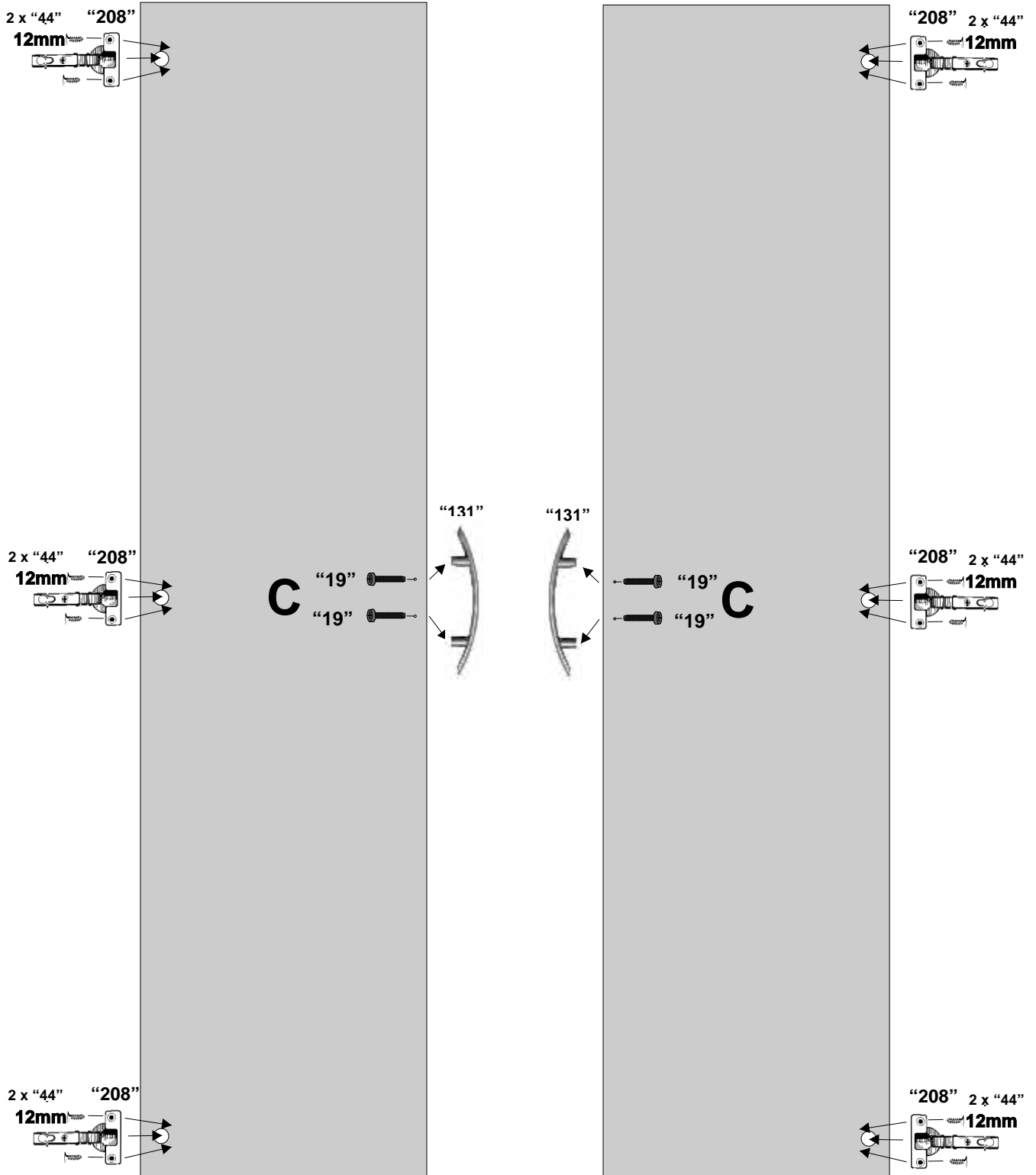
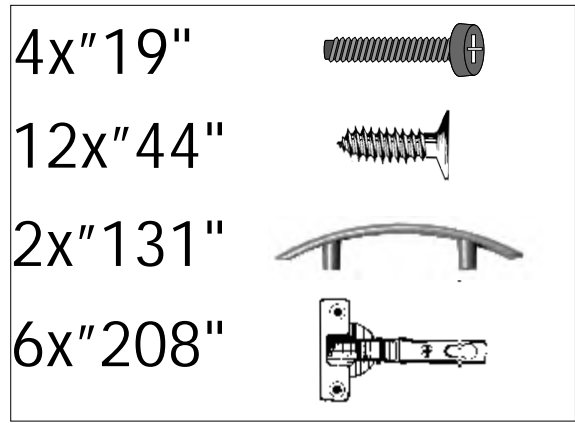

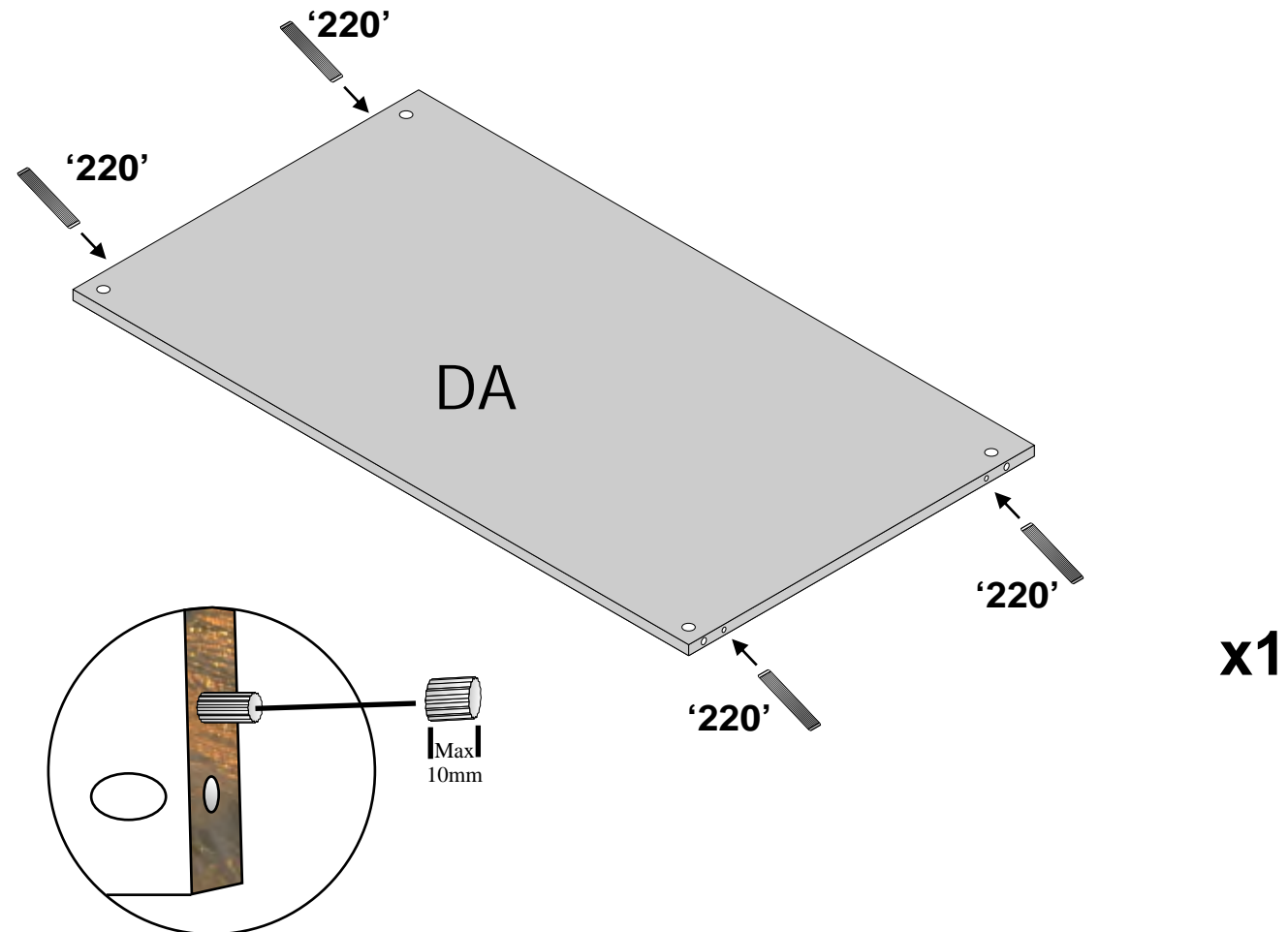
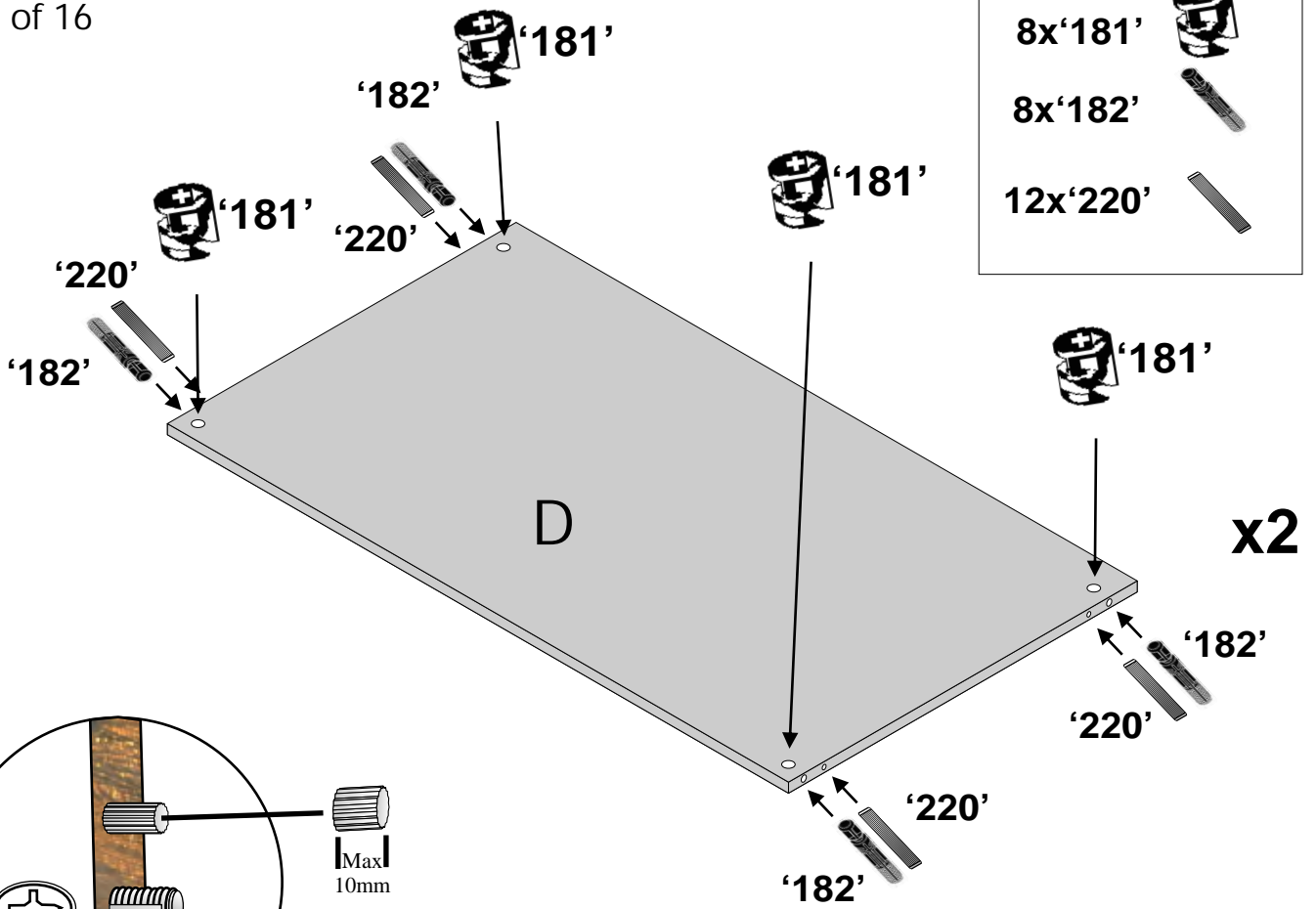

- 8x'181'
- 8x'182'
- 12x'220'

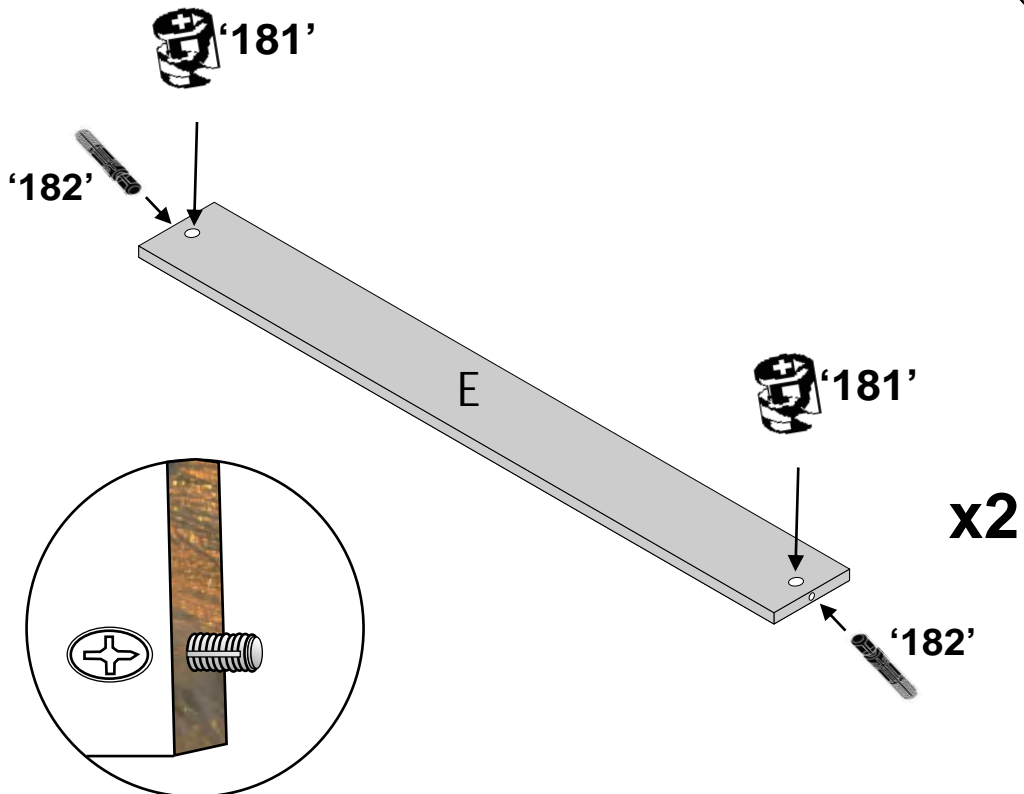
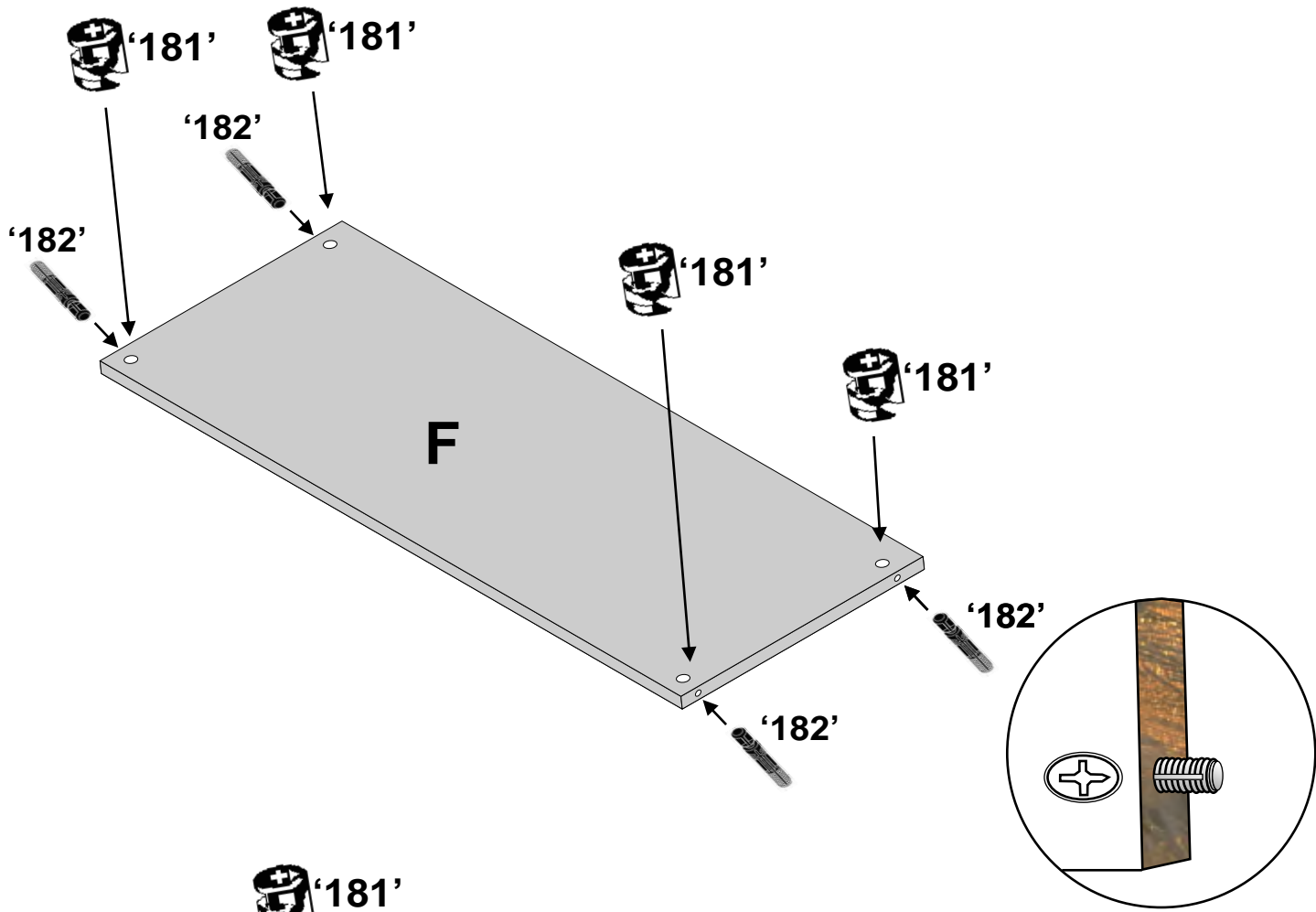

8x'181'  
8x'182'



IT IS SUGGESTED THAT THE B PANEL IS LAID ON THE GROUND AND THE D, DA, E AND F PANELS ARE PUT INTO IT IF THE FLOOR IS NOT CARPETED THEN LAY A DUST CLOTH OR SIMILAR DOWN UNDER THE B PANEL TO AVOID DAMAGE

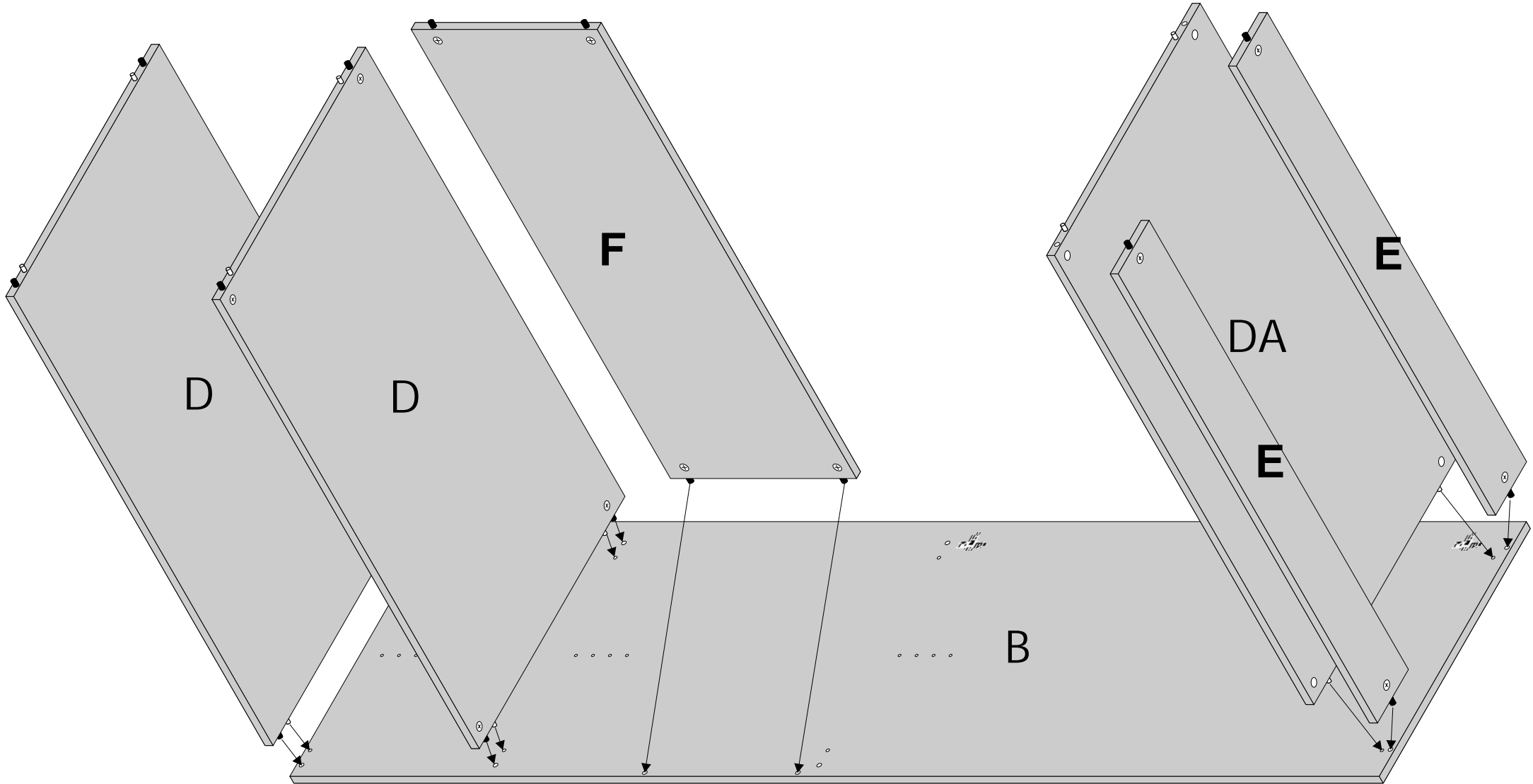



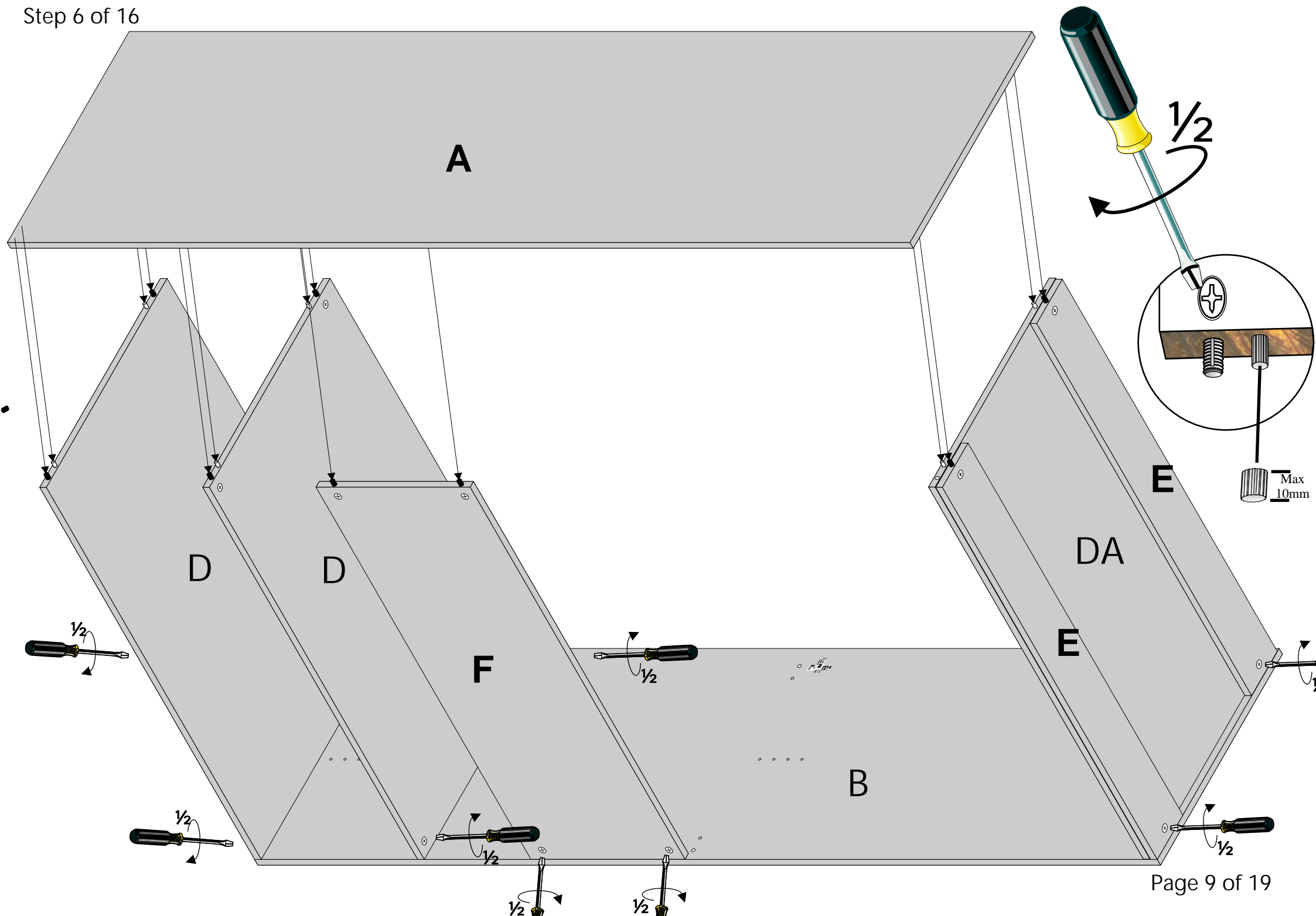

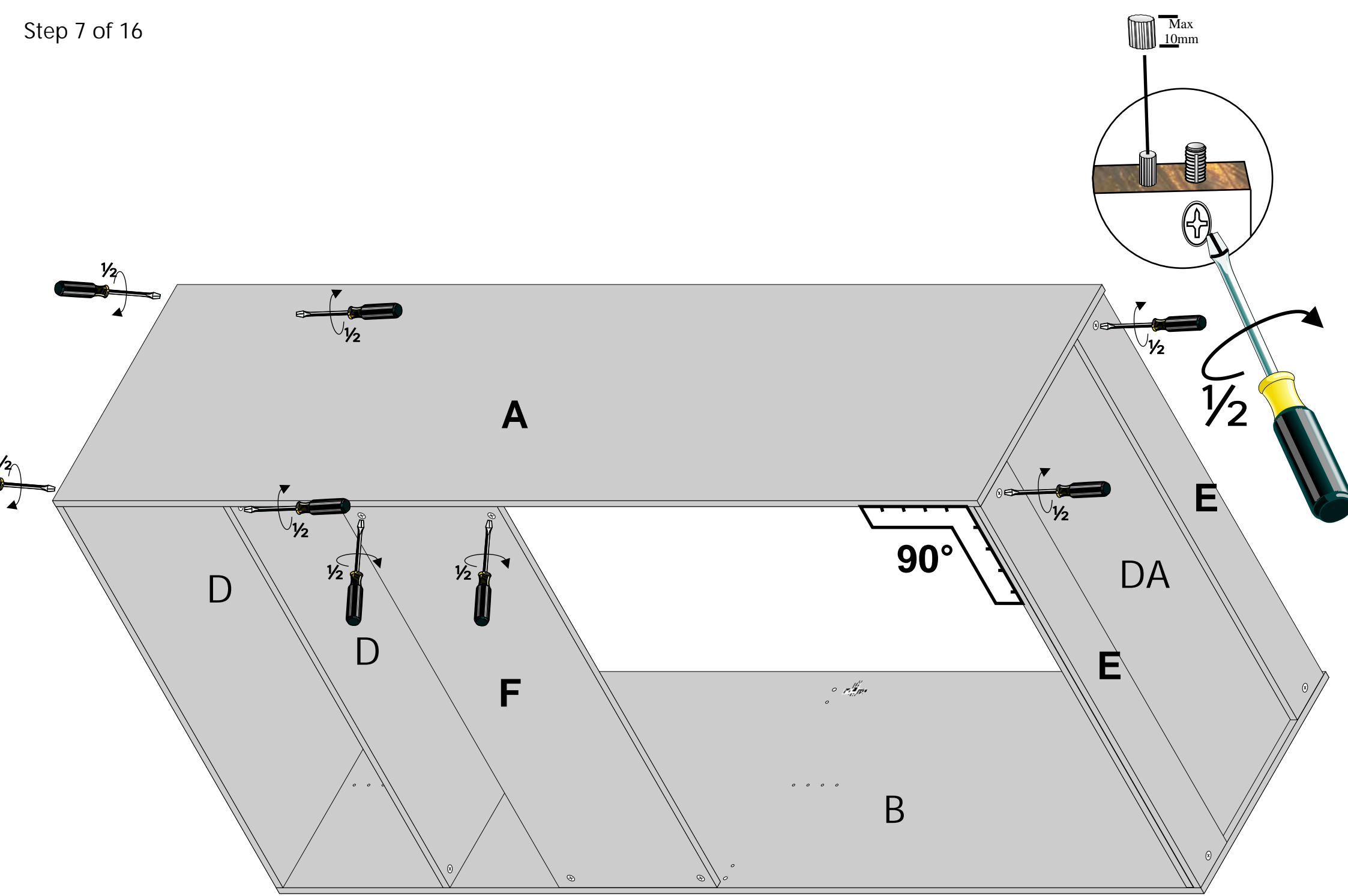

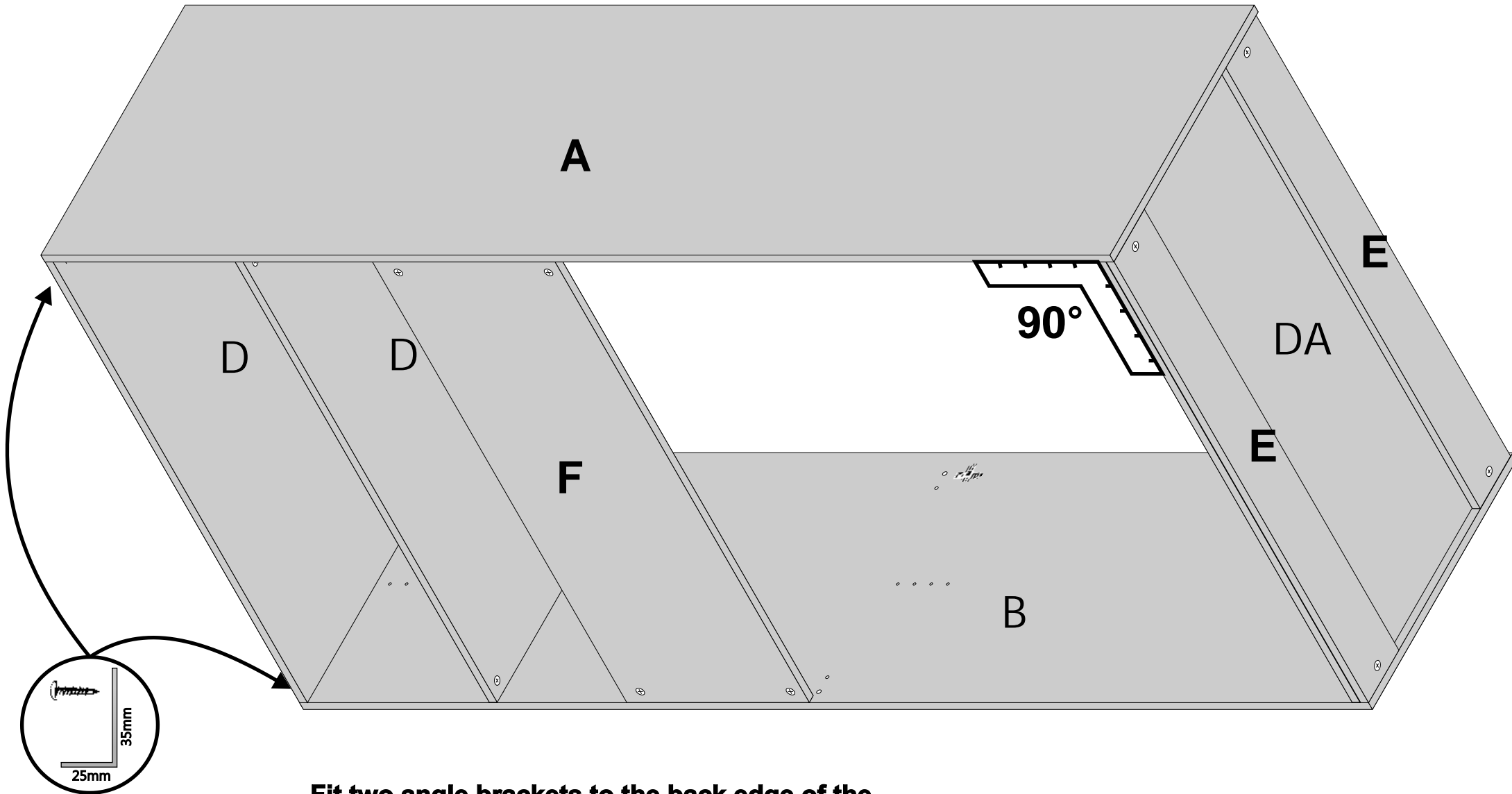

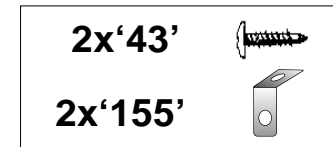

**Fit two angle brackets to the back edge of the top of the cabinet. This can then be used to secure the cabinet to the wall. Use a wall fixing that is suitable for your wall, not supplied.**

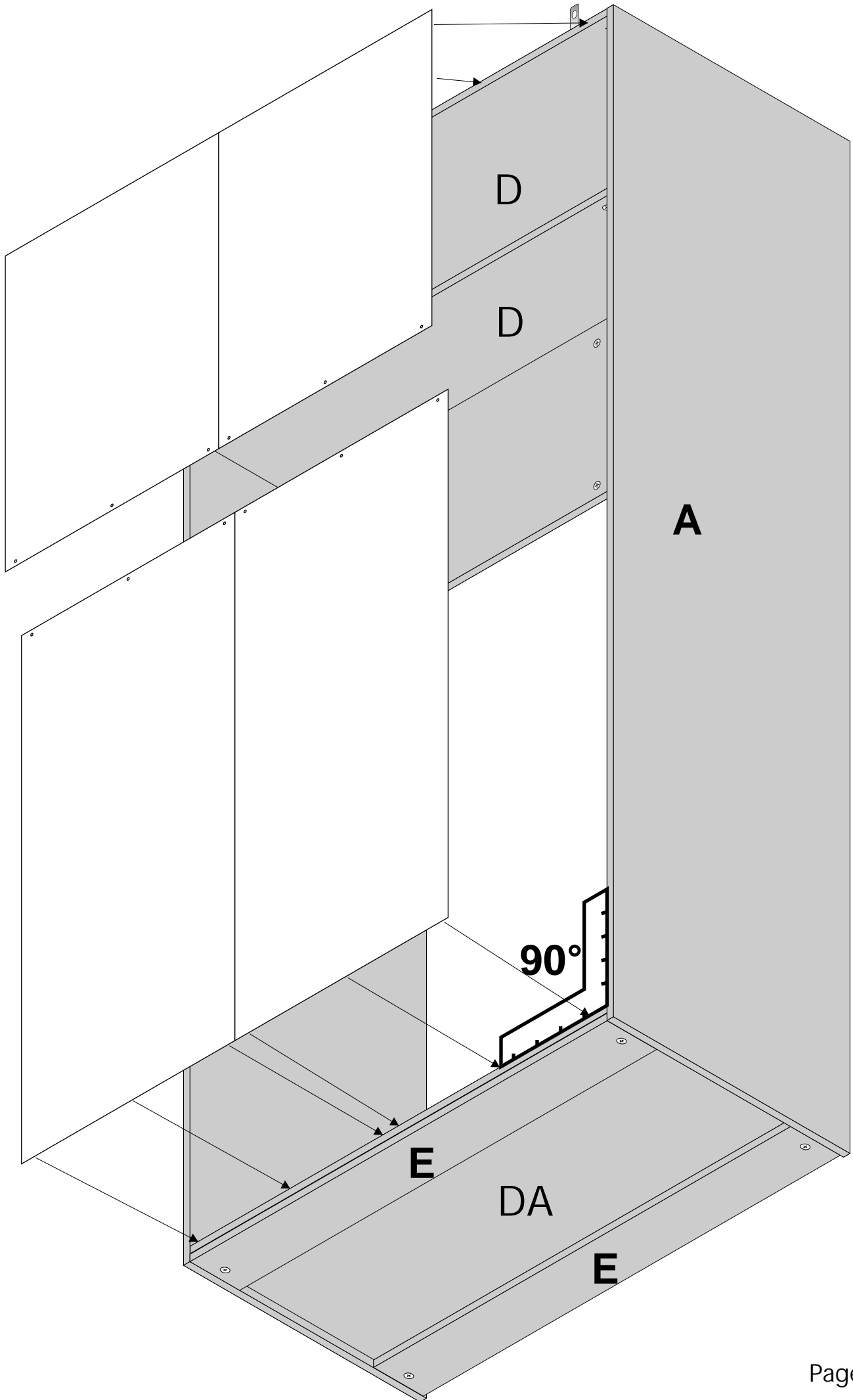

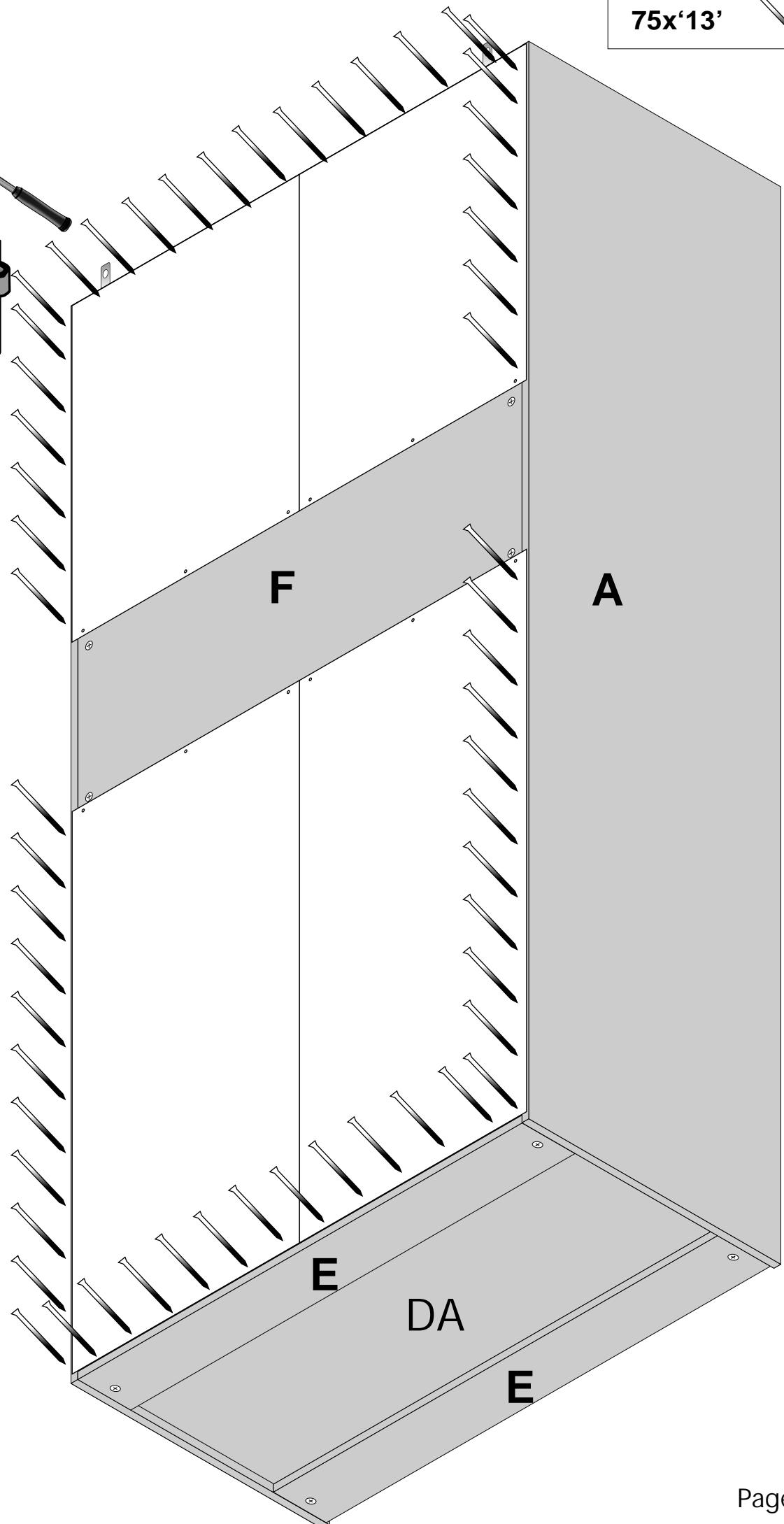
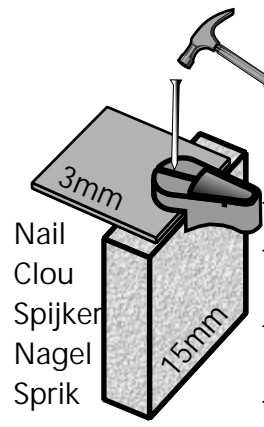



12x'43' 

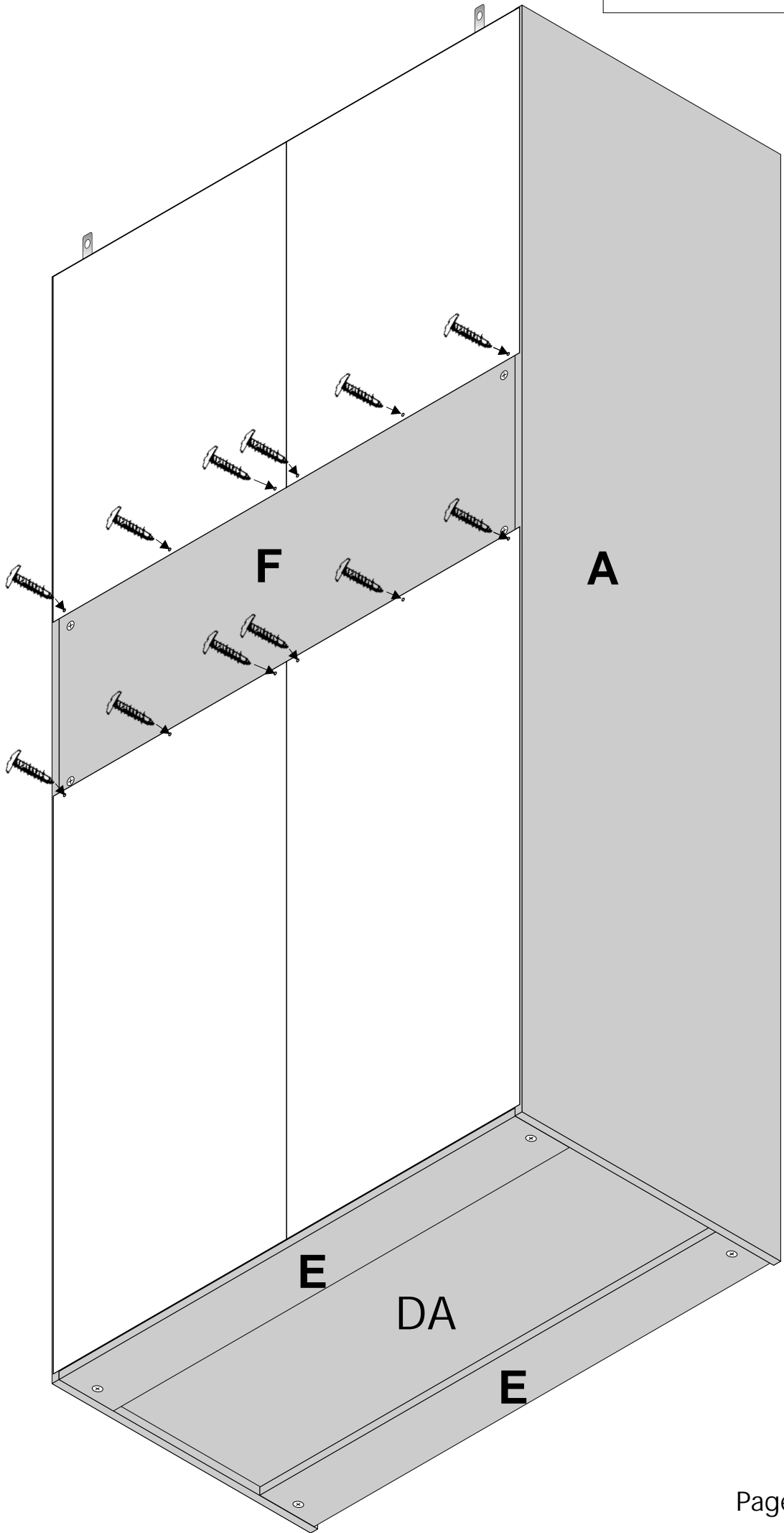

2x'44' 

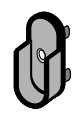
2x'118' 

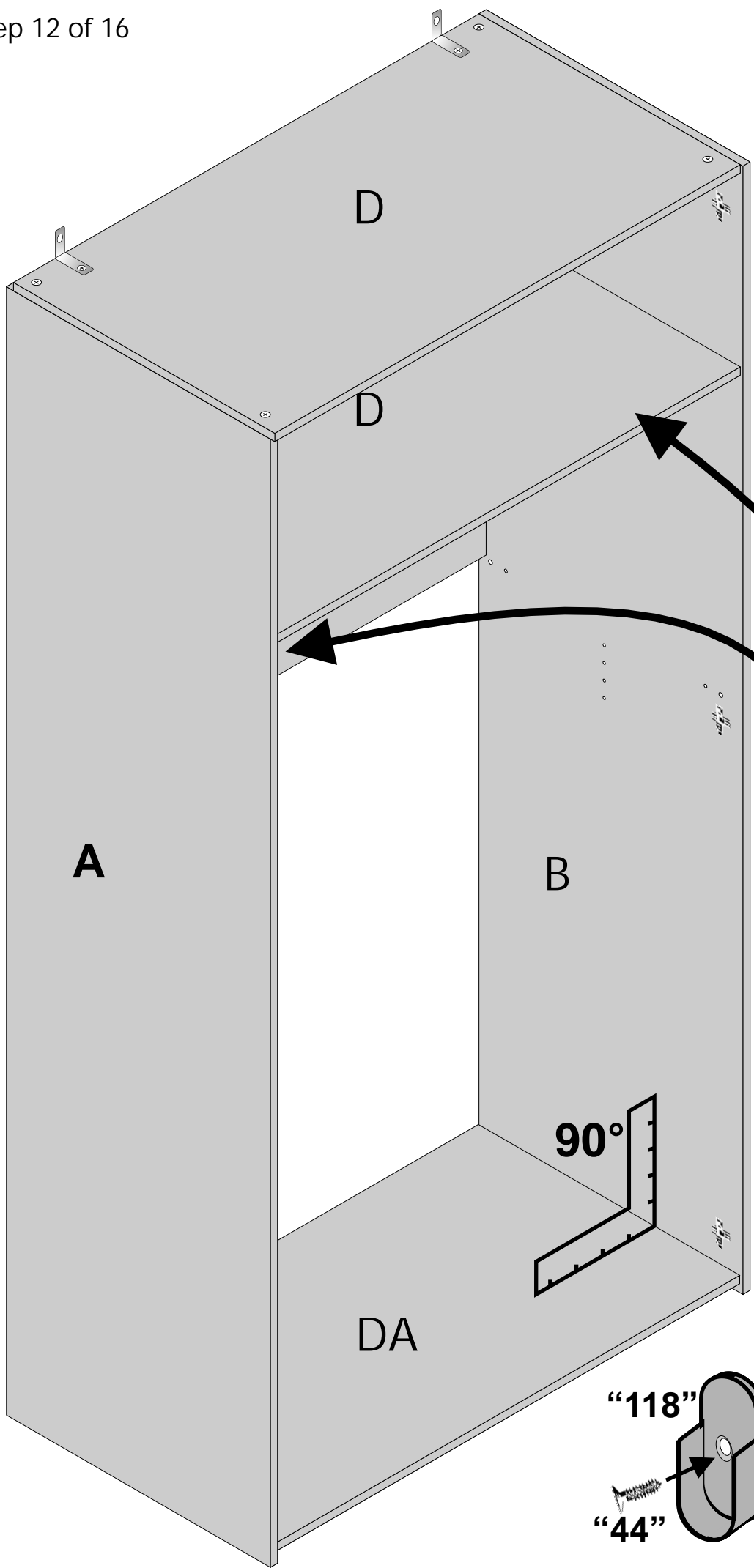

"118"

"44"

A detailed callout diagram showing a corner bracket being attached to a panel edge. A screw is shown being inserted into the bracket. The dimension "118" is indicated for the distance from the top edge of the panel to the top of the bracket. The dimension "44" is indicated for the distance from the side edge of the panel to the side of the bracket.

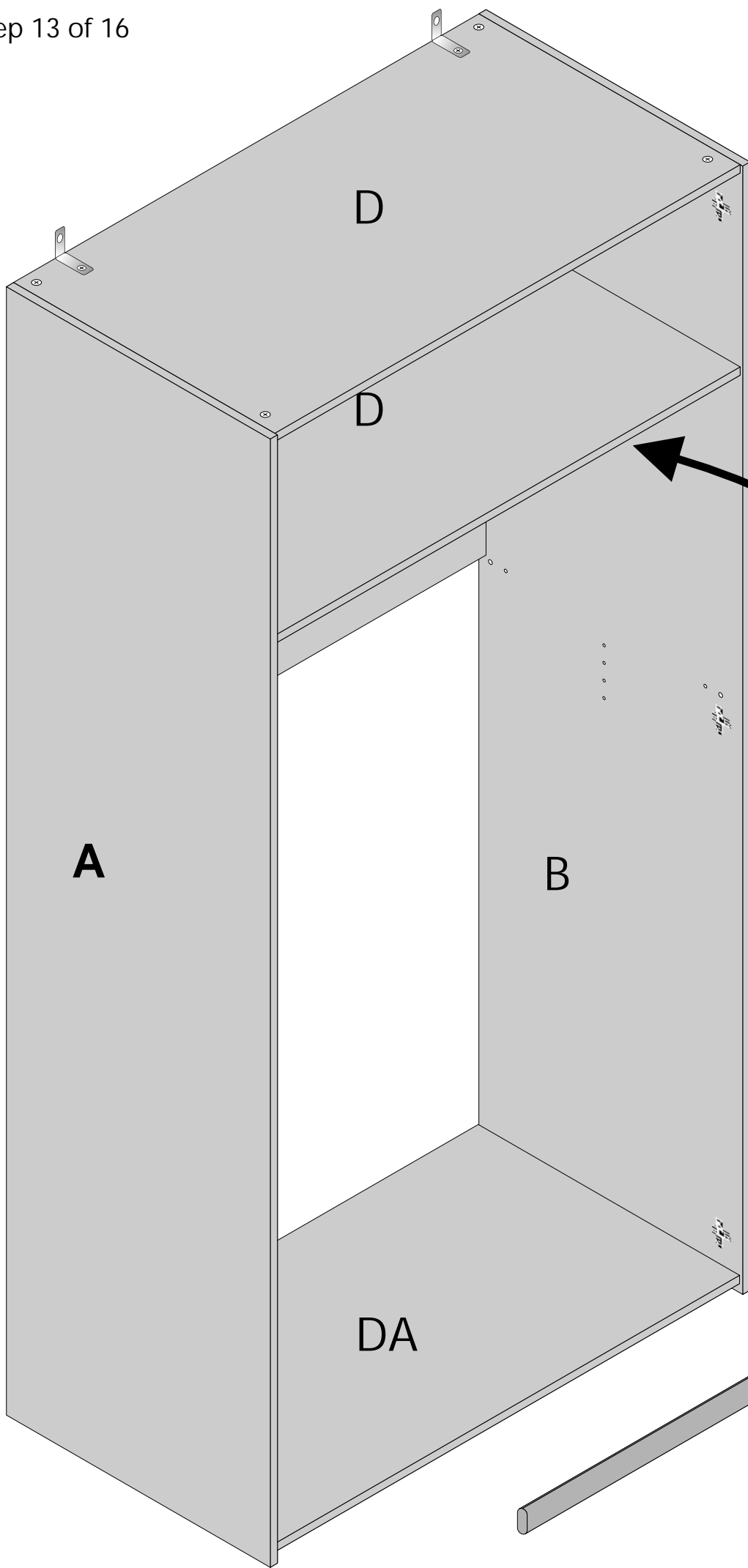
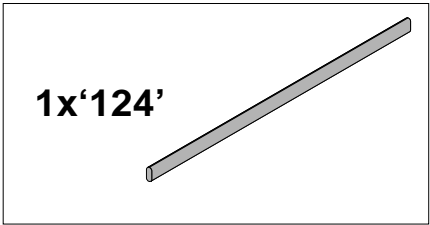

1x'124'

A

D

D

B

DA

1x'124'  
961mm



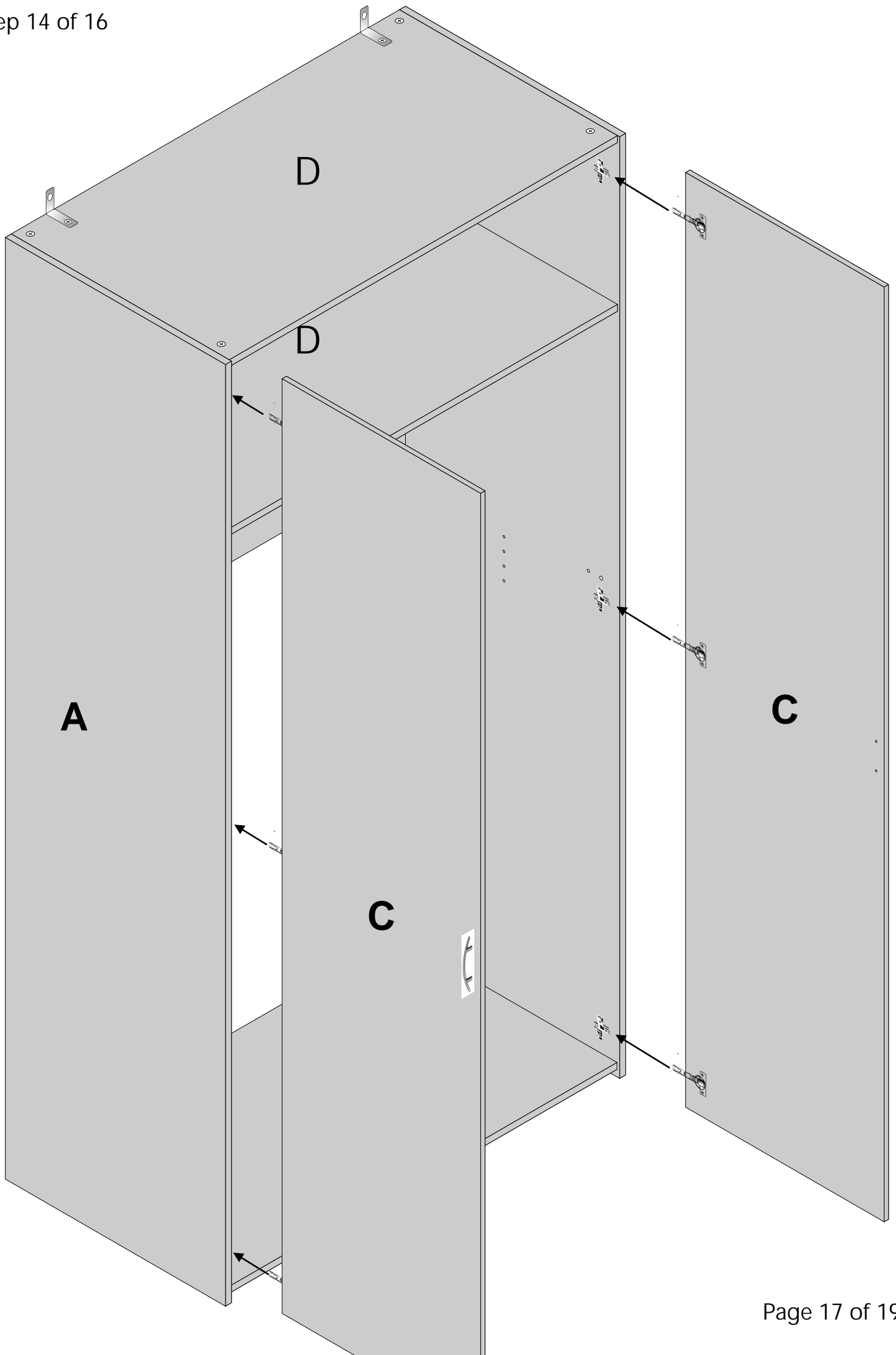

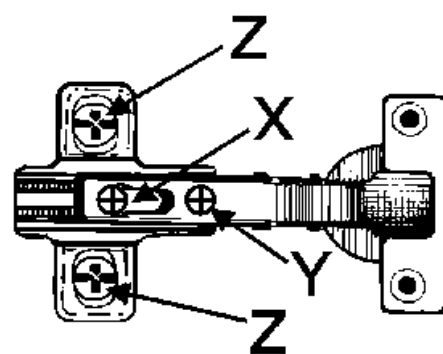
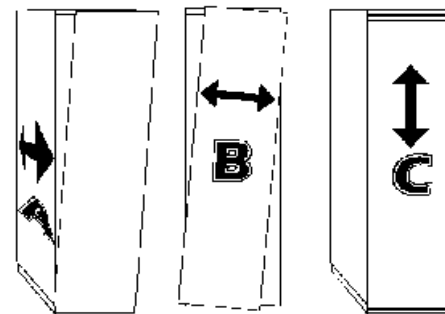
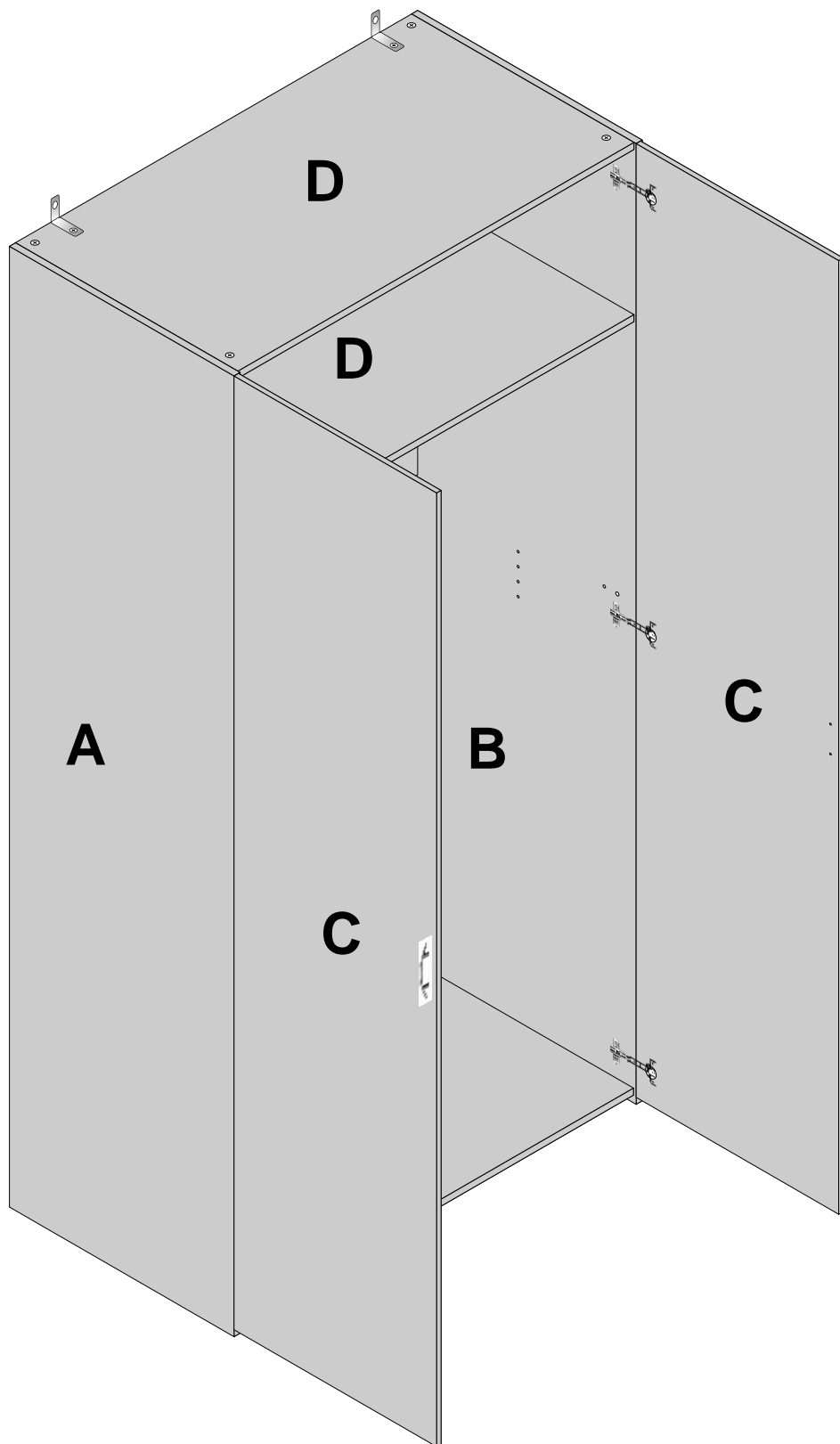

**ENGLISH  
DOOR ADJUSTMENT**

Fit the door when the cabinet is in the final position.

**A DEPTH ADJUSTMENT**

Release the screw X to adjust the door for forward or back movement. Tighten the screw X when correct.

**B SIDE ADJUSTMENT**

Loosen screw X, adjust screw Y in or out, tighten screw X.

**Z HEIGHT ADJUSTMENT**

Release the hinge plate screws and adjust up or down. Tighten when correct.

4x'116'

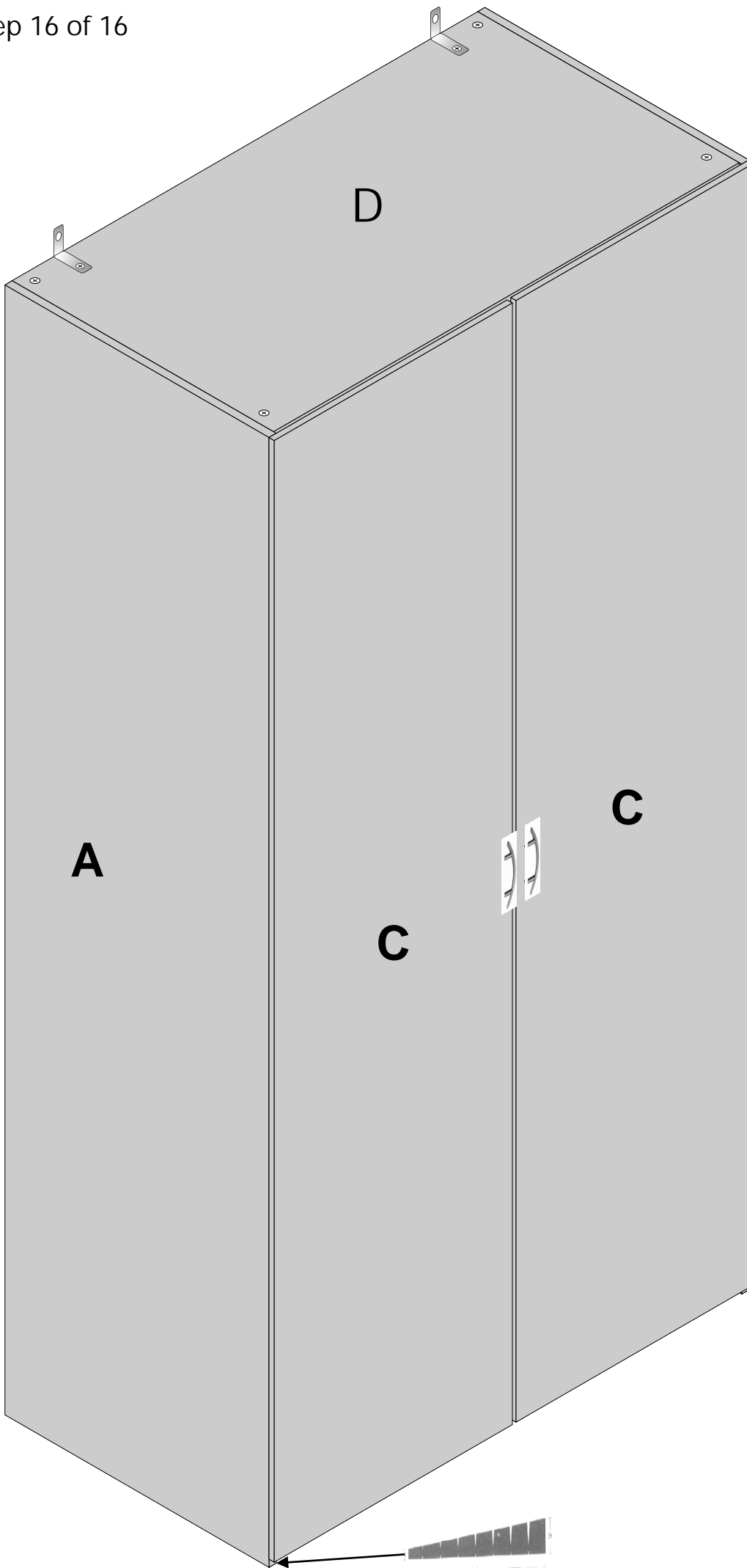
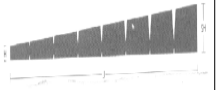

**Four levelling wedges are provided to allow the wardrobe to be levelled as required**

